

EN

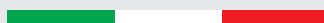

part of nVent HOFFMAN

# GENERAL CATALOGUE



MADE IN ITALY

[nVent.com](http://nVent.com)





# texa industries

---

Company	6
Vision	8
Technology and Innovation	10
After-sales	12
Green Commitment	14

# Air conditioning Range



## **NXT**

Door- or wall-mount air conditioners

20

## **FLY**

Door- or wall-mount air conditioners

36

## **EGOS3 - 60 - 80 - A0 - A5**

Door- or wall-mount air conditioners

44

## **DEK**

Roof-mount air conditioners

52

## **NOX**

Wall-mount air conditioners for outdoor applications

62

## **EMO60 - 80 - A0**

Wall-mount air conditioners for outdoor applications

74

## **BLU - BIT**

Air-water heat exchangers

80

## **MIX**

Air-air heat exchangers

92

## **FAN**

Ventilation units with filter

98

## **DLK**

Ventilating towers

108

## **WID**

Anti-condensation heaters

112

# Refrigeration Range

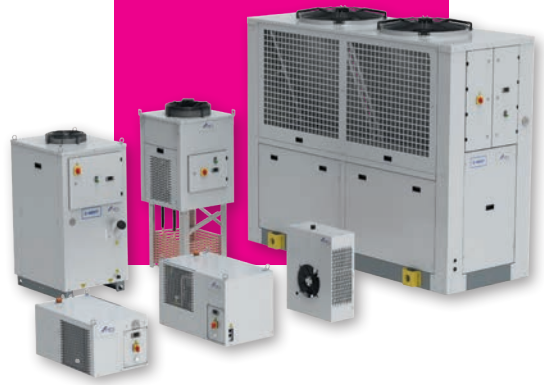

## **TCW minichiller - TAL**

Industrial water chillers

130

## **TCO minichiller - TAO**

Industrial oil chillers

148

## **TCI**

Immersion coil chillers

164

## **TAU**

Industrial chillers for contaminated or dirty fluids

170

## **SAW**

Water-air heat exchangers

176

## **AIR CONDITIONING ACCESSORIES**

120

## **REFRIGERATION ACCESSORIES (TEXA FLUID)**

182



# An Italian company focusing on good customer service

On the leading-edge of industrial air conditioning  
and cooling



Dynamic and rich in experience, texa industries gives quality and reliability, with products **made in Italy**, a blueprint that has led it to become a worthy player in the market and a solutions partner of choice.

Texa industries has cemented its reputation as a solid company across Italy.

**Choosing texa industries** means putting yourself in the hands of a dependable partner that has far-reaching awareness of the role it plays in the market and embraces the future and the challenges it will bring with trust.

# Into the future from a solid foundation

**Texa industries wants to give continuity to the work carried out to date by making a considerable investment in cutting-edge technology and new production space**

The new facility has enabled the implementation of **three modern test chambers** and an **innovatively designed automatic line** in the air conditioning department, which is equipped with a range of 4.0 systems at the cutting-edge of industrial cooling technology.

We are a company of highly specialised engineers and commercial technicians providing a complete and qualified service, working alongside customers at every stage.

As a flexible company, we have the ability to adapt and to develop the most appropriate solution for any given situation. You can count on us to turn around problems and quickly meet your requirements, creating a **tailor-made product** just for you.

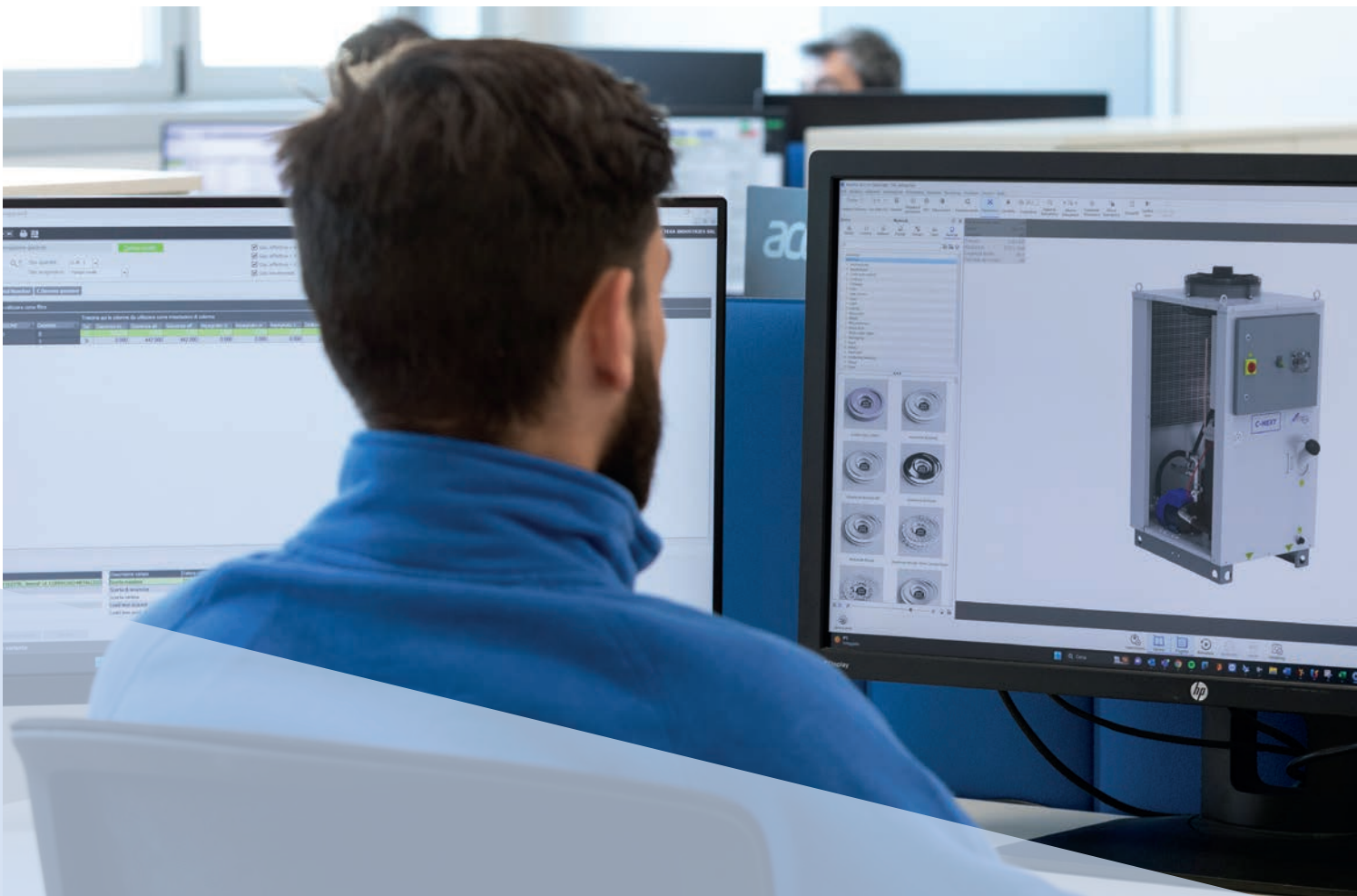





## The company has two large departments, one for each product category (chillers and air conditioners)

The operations and investments that have gone into the company's Pegognaga facility and manufacturing lines over the last few years were designed so that we could always be ready with a comprehensive response to the needs of the industrial cooling and air conditioning market. We did this with only one aim in mind: to give customers a **competitive** and **technologically-advanced product** manufactured to the **highest quality standards**.

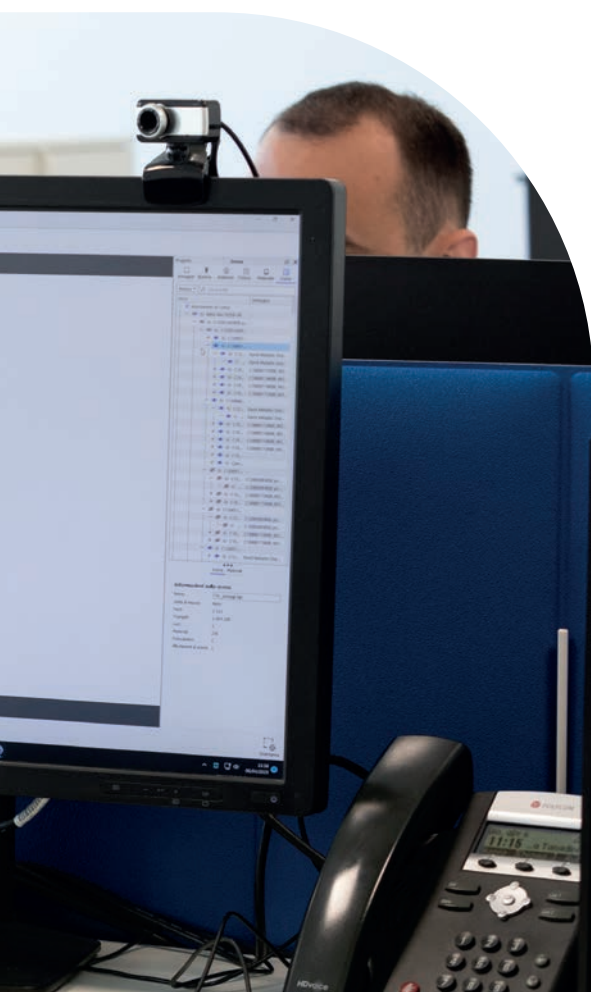

# Technology and innovation ingrained in our heart

The work of our R&D department has always been geared towards finding and researching new technologies

At **texa industries** we use some of the most advanced design technologies in the industry. Company processes are aimed towards making technical information and processing diagrams easily accessible to operators in order to optimise and control the processes at every step.

Driven by continuous development and improvement, we completed three new test chambers and are now able to test products even under extreme conditions. This means delivering more comprehensive data to end customers, who will also have the possibility to connect to the machine in real time and have more elements at hand.

This drive to research into new technologies and production processes makes the company flexible, its production swifter, and its dedication to quality more focused, also via 100% end-of-the-line testing of products. Furthermore, at **texa industries** speed and on-time delivery are two essential values, with orders confirmed within 5 business days of receipt.

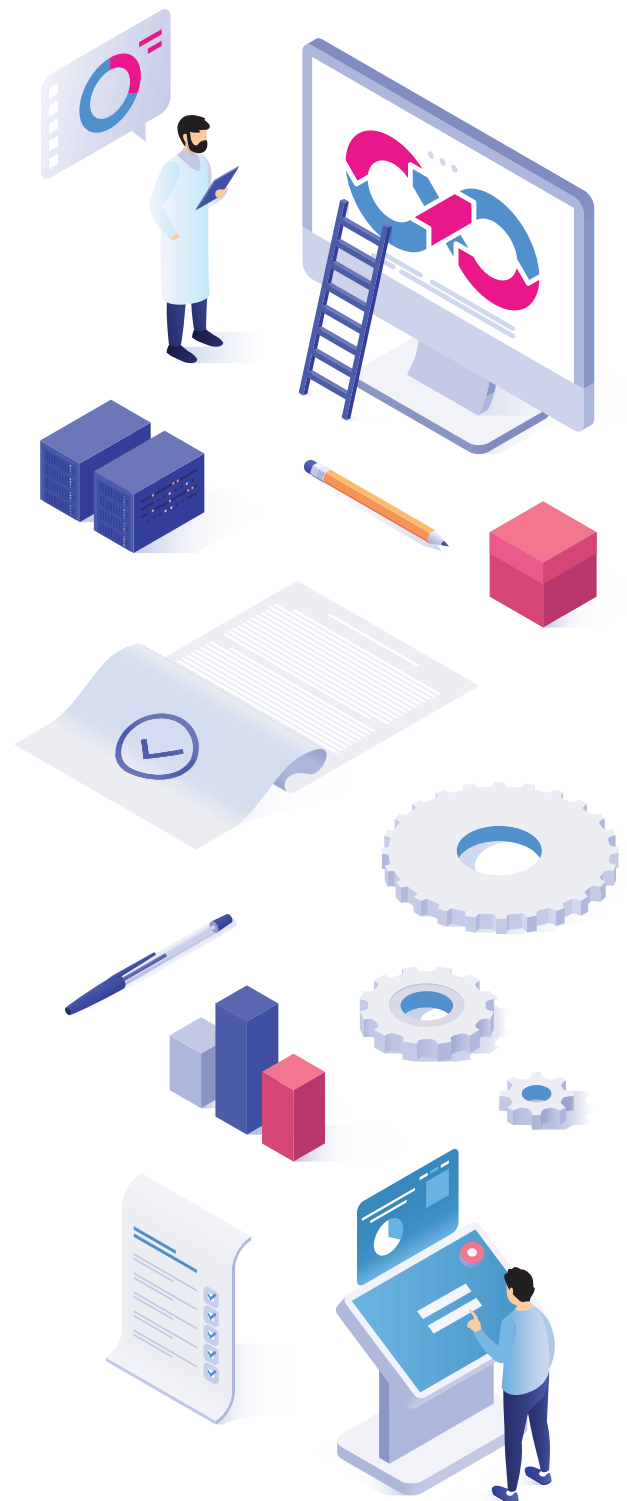

## COMPANY CERTIFICATION ISO 9001 - TÜV



The company is certified according to the stringent standards of organisational efficiency and product quality, minimising waste, avoiding errors and increasing productivity.

## CE PRODUCT CERTIFICATION



## UL PRODUCT CERTIFICATION



# Fast and efficient bespoke service

**The team at texa industries is always striving to find the best solutions, focusing on timeliness and efficiency**

In-depth knowledge of the market and its dynamics, together with high-level competence and cutting-edge technologies, enable **texa industries** to be recognised by customers as a **reliable partner** in industrial cooling systems.

One of the characteristics we are most known for is our short lead times. Speed is a household word at the company. We are fast to receive and confirm orders and quick to deliver in a market requiring faster and more reliable service than ever before.

**Texa industries** industrial air conditioners and chillers are designed to satisfy every requirement, but the team is ready to develop custom solutions for any unique situation.



# A global partner

**At texa industries we co-create with customers to come up with the solution that best satisfies their needs and requirements**

What's more, the company boasts a direct presence in the international market through a dense global network of Agencies and Partners that ensures timely, fast and widespread coverage and keeps quality standards high at all times.



**“ Our Customers can be sure to collaborate with a responsive and reliable partner that can cover all of their needs ”**



**30**

**COUNTRIES SERVED**



**100**

**EMPLOYEES**



**25,000**

**AIR CONDITIONERS  
PER YEAR**



**8,000**

**REFRIGERATORS  
PER YEAR**

## After-sales network

Thanks to this widespread network, speed, flexibility, and precision remain at the forefront of our support service. These crucial values mean that texa industries is constantly looking forward and going above and beyond.

At **texa industries**, Customer Service has become established and is an integral part of every stage in the life of the product from installation, and throughout its use.

# Zero-emissions target

**The commitment to greater sustainability has always been a feather in texa industries' cap**

We know that what we do has a significant impact on the environment. That's why we have chosen to chart a greener course. Thanks to photovoltaic panels, **35% of the company's energy needs comes from a renewable energy source.** The new manufacturing plant will also leverage natural light, helping to reduce electric energy waste.



# Increasingly sustainable products

At texa industries our commitment goes beyond our manufacturing plant; we are constantly working to have more and more low-impact products

The massive amount of policies introduced to reduce the environmental impact of **texa industries'** entire production chain has led to remarkable results in recent years. To name a couple of important examples, we are increasingly providing our user manuals in dematerialised form

and **have removed plastic from our packaging.** In addition, **texa industries** products use technologies that help to drastically reduce refrigerant use **without affecting performance,** resulting in significantly lower greenhouse gas emissions.



# Air conditioning range



**A comprehensive range of industrial air conditioners for indoor or outdoor application.**





# At the heart of technology

## There are numerous reasons to choose a texa Industries cooling system

By listening to our Customers and harnessing our long experience in the industrial sector, we have built a comprehensive offering of **high-quality cutting-edge products** in the area of industry 4.0 systems applied to climate control.

Our strong product engineering has allowed us to standardise and include many previously optional extras as standard equipment throughout the range.

The new E-NEXT range has achieved the top certifications in our industry, including the UL LISTED seal for the U.S. and Canada.



### CONDENSATE DISCHARGE

Safety first! All air conditioners are equipped with an external condensate drain, ensuring the safety of the systems in any and all situations.

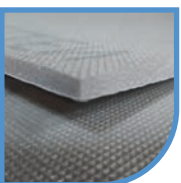

### DIE-CUT SEALS

To achieve a perfect seal between the electrical panel and the air conditioner, **texa industries** provides an integrated seal that ensures simple installation and perfect adhesion between the surfaces.



## EXTERNAL OR SEMI-RECESSED INSTALLATION

The entire E-NEXT range can be ordered for external installation (standard) or for external and semi-recessed installation, giving you maximum flexibility.



## LOWER MAINTENANCE COSTS

Using latest-generation microchannel technology air conditioners brings with it fast and effective maintenance over the years, not to mention 30% savings on refrigerant.

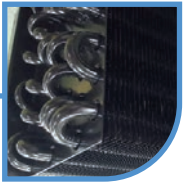

## OUTDOOR APPLICATIONS

A range of specific air conditioning units for outdoor applications, the cataphoresis treatment of the condensing coil and the IP54-rated protection of all electrical components make this product reliable in all atmospheric conditions.



## EASY TO INSTALL FILTER

The new magnetic filter support fastening system makes maintenance super simple and preserves the attractive design of the E-NEXT range.



## THERMOSTAT WITH DIGITAL DISPLAY

The new TX-i40 thermostat provides complete and flexible management of the air conditioner, ensuring easy management and connectivity via MODBUS protocol.



## PASSIVE CONDENSATE DISSIPATOR

Standard on all vertical air conditioning units from 1000W, this dissipation system saves energy as it draws no power, eliminating condensate without the need to channel it externally.

# E-NEXT

## Door- or wall-mount air conditioners



### GAS

Air conditioners all come pre-charged with R134a refrigerant



### INTEGRATED MODBUS

All air conditioners with TX-i40 can be provided with MODBUS RTU RS485 connection on request.



### ADVANCED SEQUENCING

All units are equipped with connection to sequence the operation of two air conditioners. This option allows back-up operation and distribution of operating hours.



### ADVANCED MICROPORT

Customers can easily program whether or not to lock the internal fan when the microport opens.



### ECO MODE

Standard feature on the entire range to optimise electricity use under low working load conditions.



### °C / °F

Change only one parameter to go from Celsius to Fahrenheit.



### PREDICTIVE MAINTENANCE

An advanced system enables the air conditioner to self-learn and alert the user when maintenance is due.



### SERVICE MODE

Runs a simple check procedure to ensure the air conditioner is working properly; useful during installation.



### HUMIDITY CONTROL

This option (supplied on request) uses a humidistat to control the humidity inside the cabinet; ideal for applications in tropical areas.

### EC EC FANS

Available on request, electronic fans increase air conditioner efficiency by further reducing energy consumption and related operating costs.



### LOW-NOISE VERSION

Available on request, the version with reduced modulated speed fans enables low-noise operation in outdoor residential or commercial applications.



# NXT04

## Door- or wall-mount air conditioners

COOLING CAPACITY 380 W

### DIMENSIONS

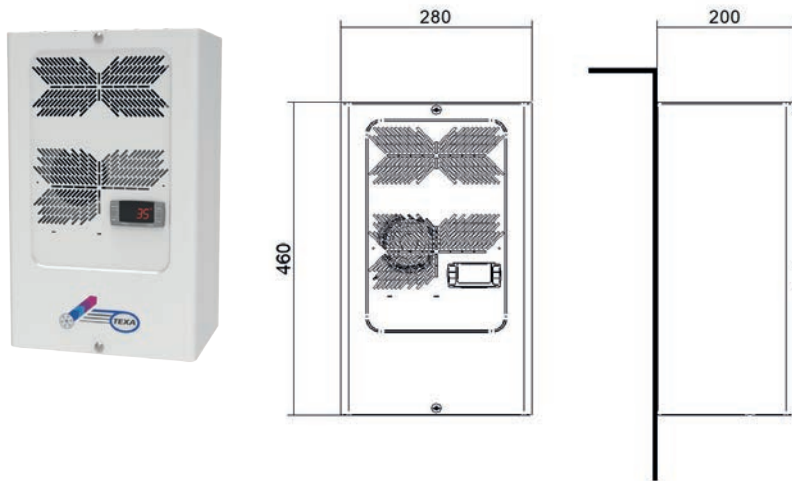

### PERFORMANCE

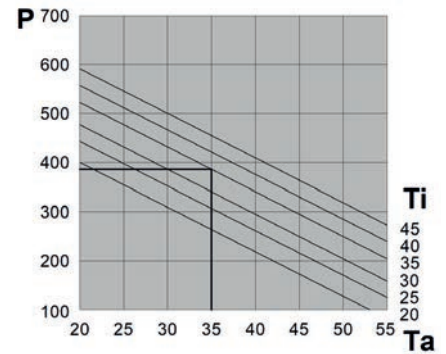

- P = Cooling capacity (W)
- Ta = Ambient Temperature (°C)
- Ti = Internal cabinet temperature (°C)

Features	UoM	NXT04B0T1C00000	NXT04K0T1C00000	NXT04B0T1U00000	NXT04C0T1U00000
Cooling capacity EN14511 - A35A35	W	380	380	380	380
Cooling capacity EN14511 - A35A50	W	240	240	240	240
Power supply	V ~ Hz	230 - 1 - 50/60	400/460 - 2 - 50/60	230 - 1 - 50/60	115 - 1 - 60
Width - Height - Depth	mm	280 - 460 - 200	280 - 460 - 200+55*	280 - 460 - 200	280 - 460 - 200
Max current	A	1.5	0.9	1.5	3.4
Inrush current	A	8.6	5	8.6	22.6
T Fuse	A	4	2	4	6
Power draw EN14511 - A35A35	W	240	240	240	240
Power draw EN14511 -A35A50	W	277	277	277	277
Electrical connection	-	4-pin plug	4-pin plug	4-pin plug	4-pin plug
Cabinet air fan capacity	m <sup>3</sup> /h	165	165	165	165
Internal temperature range	°C	20-45	20-45	20-45	20-45
Temperature regulation	-	Electronic thermostat TX050 factory set to 35°C			
External temperature range	°C	20-55	20-55	20-55	20-55
Ingress protection - cabinet side	-	IP55	IP55	NEMA TYPE 12	NEMA TYPE 12
Noise level	dB (A)	60	60	60	60
Weight	kg	17	20	17	17
Conformity	-	CE UK CA	CE UK CA	CE UK CA	CE UK CA

\* for autotransformer external dimensions  
semi-recessed installation version page 35

# NXT06

## Door- or wall-mount air conditioners

COOLING CAPACITY 720 W

### DIMENSIONS

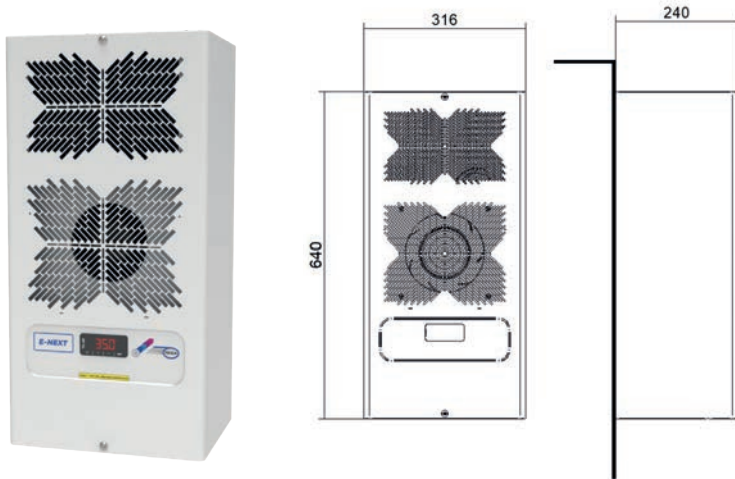

### PERFORMANCE

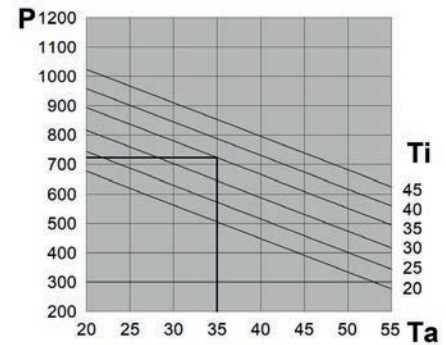

- P = Cooling capacity (W)
- Ta = Ambient Temperature (°C)
- Ti = Internal cabinet temperature (°C)

Features	UoM	NXT06B0E1C00000	NXT06K0E1C00000	NXT06B0E1U00000	NXT06C0E1U00000	NXT06V0E1C00000
Cooling capacity EN14511 - A35A35	W	720	720	720	720	720
Cooling capacity EN14511 - A35A50	W	555	555	555	555	555
Power supply	V ~ Hz	230 - 1 - 50/60	400/460 - 2 - 50/60	230 - 1 - 50/60	115 - 1 - 60	48VDC
Width - Height - Depth	mm	316 - 640 - 240	316 - 640 - 240	316 - 640 - 240	316 - 640 - 240	316 - 640 - 240
Max current	A	2.3	1.3	2.3	4.3	5.8
Inrush current	A	10.9	6.3	10.9	22.2	-
T Fuse	A	6	4	6	8	10
Power draw EN14511 - A35A35	W	380	380	380	420	280
Power draw EN14511 -A35A50	W	450	450	450	500	350
Electrical connection	-	4-pin plug	4-pin plug	4-pin plug	4-pin plug	4-pin plug
Cabinet air fan capacity	m <sup>3</sup> /h	305	305	305	305	305
Internal temperature range	°C	20-45	20-45	20-45	20-45	20-45
Temperature regulation	-	Electronic thermostat TX-i40 factory set to 35°C				Mech. thermostat
External temperature range	°C	20-55	20-55	20-55	20-55	20-55
Ingress protection - cabinet side	-	IP55	IP55	NEMA TYPE 12	NEMA TYPE 12	IP55
Noise level	dB (A)	65	65	65	65	65
Weight	kg	24	26	24	24	24
Conformity	-	CE UK CA	CE UK CA	UL CE UK CA	UL CE UK CA	CE UK CA

Version for semi-recessed installation page 35

# NXT08

## Door- or wall-mount air conditioners

COOLING CAPACITY 880 W

### DIMENSIONS

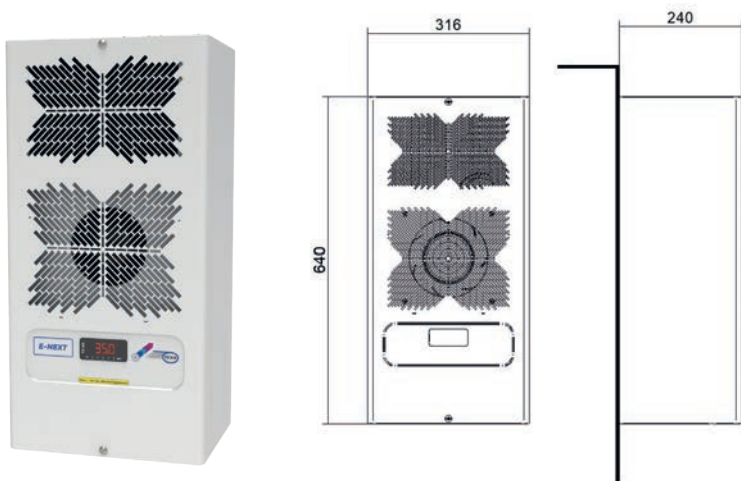

### PERFORMANCE

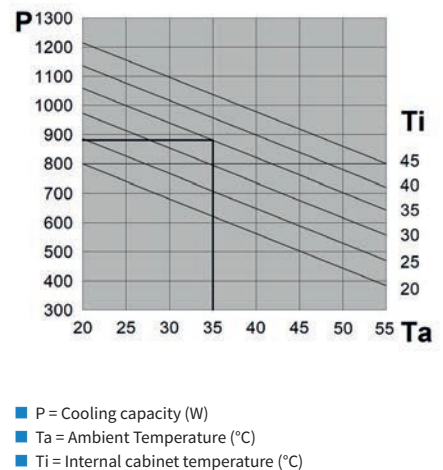

Features	UoM	NXT08B0E1C00000	NXT08K0E1C00000	NXT08B0E1U00000	NXT08C0E1U00000	NXT08V0E1C00000
Cooling capacity EN14511 - A35A35	W	880	880	880	880	880
Cooling capacity EN14511 - A35A50	W	705	705	705	705	705
Power supply	V ~ Hz	230 - 1 - 50/60	400/460 - 2 - 50/60	230 - 1 - 50/60	115 - 1 - 60	48VDC
Width - Height - Depth	mm	316 - 640 - 240	316 - 640 - 240	316 - 640 - 240	316 - 640 - 240	316 - 640 - 240
Max current	A	2.4	1.4	2.4	4.2	6
Inrush current	A	12.9	7.4	12.9	22.2	-
T Fuse	A	6	4	6	8	10
Power draw EN14511 - A35A35	W	450	450	450	430	350
Power draw EN14511 - A35A50	W	520	520	520	540	420
Electrical connection	-	4-pin plug	4-pin plug	4-pin plug	4-pin plug	4-pin plug
Cabinet air fan capacity	m <sup>3</sup> /h	325	325	325	325	325
Internal temperature range	°C	20-45	20-45	20-45	20-45	20-45
Temperature regulation	-	Electronic thermostat TX-i40 factory set to 35°C				Mech. thermostat
External temperature range	°C	20-55	20-55	20-55	20-55	20-55
Ingress protection - cabinet side	-	IP55	IP55	NEMA TYPE 12	NEMA TYPE 12	IP55
Noise level	dB (A)	65	65	65	65	65
Weight	kg	25	27	25	25	25
Conformity	-	CE UK	CE UK	CE UK	CE UK	CE UK

Version for semi-recessed installation page 35



# NXT10

## Door- or wall-mount air conditioners

COOLING CAPACITY 1000 W

### DIMENSIONS

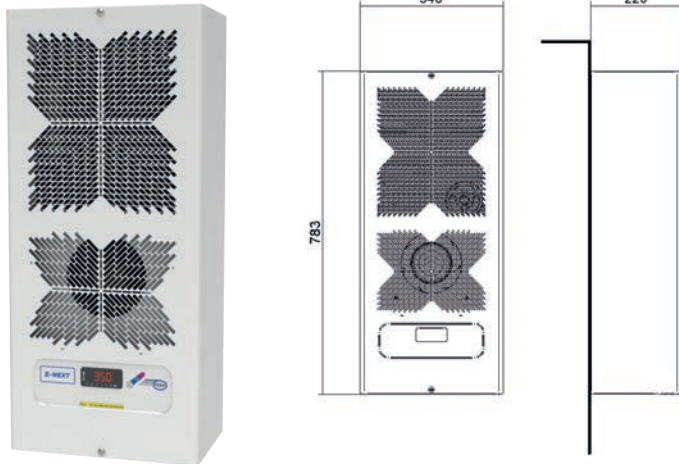

### PERFORMANCE

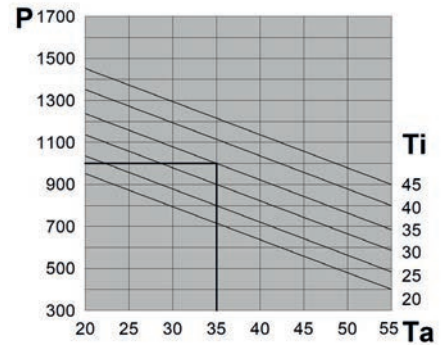

- P = Cooling capacity (W)
- Ta = Ambient Temperature (°C)
- Ti = Internal cabinet temperature (°C)

Features	UoM	NXT10B0E1C00000	NXT10K0E1C00000	NXT10B0E1U00000	NXT10C0E1U00000	NXT10K0E1U00000
Cooling capacity EN14511 - A35A35	W	1000	1000	1000	1000	1000
Cooling capacity EN14511 - A35A50	W	760	760	760	760	760
Power supply	V ~ Hz	230 - 1 - 50/60	400/460 - 2 - 50/60	230 - 1 - 50/60	115 - 1 - 60	400/460 - 2 - 50/60
Width - Height - Depth	mm	348 - 783 - 220	348 - 783 - 220	348 - 783 - 220	348 - 783 - 220	348 - 783 - 220
Max current	A	3	1.7	3	5.7	1.7
Inrush current	A	13.1	7.5	13.1	28	7.5
T Fuse	A	6	4	6	10	4
Power draw EN14511 - A35A35	W	500	500	500	570	500
Power draw EN14511 - A35A50	W	600	600	600	670	600
Electrical connection	-	4-pin plug	4-pin plug	4-pin plug	4-pin plug	4-pin plug
Cabinet air fan capacity	m <sup>3</sup> /h	540	540	540	540	540
Internal temperature range	°C	20-45	20-45	20-45	20-45	20-45
Temperature regulation	-	Electronic thermostat TX-i40 factory set to 35°C				
External temperature range	°C	20-55	20-55	20-55	20-55	20-55
Ingress protection - cabinet side	-	IP55	IP55	NEMA TYPE 12	NEMA TYPE 12	NEMA TYPE 12
Noise level	dB (A)	65	65	65	65	65
Weight	kg	27	29	27	27	29
Conformity	-	CE UK CA	CE UK CA	CE UK CA	CE UK CA	CE UK CA

Version for semi-recessed installation page 35

# NXT12

## Door- or wall-mount air conditioners

COOLING CAPACITY 1250 W

### DIMENSIONS

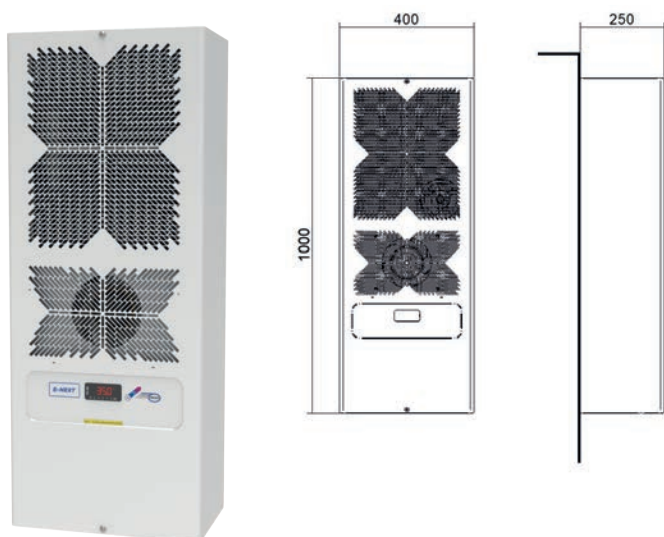

### PERFORMANCE

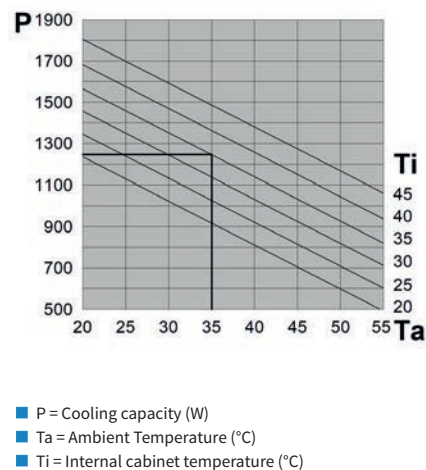

Features	UoM	NXT12B0E1C00000	NXT12K0E1C00000	NXT12B0E1U00000	NXT12C0E1U00000
Cooling capacity EN14511 - A35A35	W	1250	1250	1250	1250
Cooling capacity EN14511 - A35A50	W	930	930	930	930
Power supply	V ~ Hz	230 - 1 - 50/60	400/460 - 2 - 50/60	230 - 1 - 50/60	115 - 1 - 60
Width - Height - Depth	mm	400 - 1000 - 250	400 - 1000 - 250	400 - 1000 - 250	400 - 1000 - 250
Max current	A	3.2	1.8	3.2	6.1
Inrush current	A	17.1	9.8	17.1	28
T Fuse	A	6	4	6	10
Power draw EN14511 - A35A35	W	590	590	590	620
Power draw EN14511 - A35A50	W	680	680	680	760
Electrical connection	-	4-pin plug	4-pin plug	4-pin plug	4-pin plug
Cabinet air fan capacity	m <sup>3</sup> /h	540	540	540	540
Internal temperature range	°C	20-45	20-45	20-45	20-45
Temperature regulation	-	Electronic thermostat TX-i40 factory set to 35°C			
External temperature range	°C	20-55	20-55	20-55	20-55
Ingress protection - cabinet side	-	IP55	IP55	NEMA TYPE 12	NEMA TYPE 12
Noise level	dB (A)	65	65	65	65
Weight	kg	39	41	39	39
Conformity	-	CE UK EA	CE UK EA	CE UK EA	CE UK EA

Version for semi-recessed installation page 35

# NXT16

## Door- or wall-mount air conditioners

COOLING CAPACITY 1600 W

### DIMENSIONS

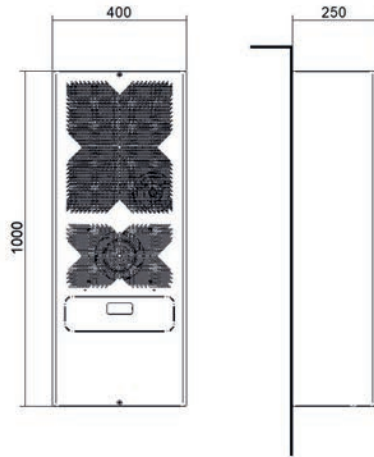

### PERFORMANCE

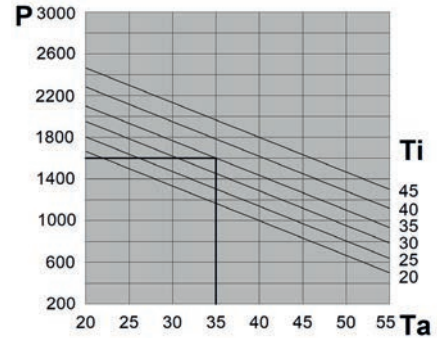

- P = Cooling capacity (W)
- Ta = Ambient Temperature (°C)
- Ti = Internal cabinet temperature (°C)

Features	UoM	NXT16B0E1C00000	NXT16K0E1C00000	NXT16B0E1U000000	NXT16C0E1U000000	NXT16K0E1U000000
Cooling capacity EN14511 - A35A35	W	1600	1600	1600	1600	1600
Cooling capacity EN14511 - A35A50	W	1100	1100	1100	1100	1100
Power supply	V ~ Hz	230 - 1 - 50/60	400/460 - 2 - 50/60	230 - 1 - 50/60	115 - 1 - 60	400/460 - 2 - 50/60
Width - Height - Depth	mm	400 - 1000 - 250	400 - 1000 - 250	400 - 1000 - 250	400 - 1000 - 250	400 - 1000 - 250
Max current	A	3.9	2.2	4.3	8.2	2.4
Inrush current	A	16.2	9.3	19.7	42	10.2
T Fuse	A	8	4	8	16	6
Power draw EN14511 - A35A35	W	720	720	720	830	720
Power draw EN14511 -A35A50	W	820	820	820	960	820
Electrical connection	-	4-pin plug	4-pin plug	4-pin plug	4-pin plug	4-pin plug
Cabinet air fan capacity	m <sup>3</sup> /h	540	540	540	540	540
Internal temperature range	°C	20-45	20-45	20-45	20-45	20-45
Temperature regulation	-	Electronic thermostat TX-i40 factory set to 35°C				
External temperature range	°C	20-55	20-55	20-55	20-55	20-55
Ingress protection - cabinet side	-	IP55	IP55	NEMA TYPE 12	NEMA TYPE 12	NEMA TYPE 12
Noise level	dB (A)	65	65	65	65	65
Weight	kg	41	43	41	41	43
Conformity	-	CE UK EA	CE UK EA	CE UK EA	CE UK EA	CE UK EA

Version for semi-recessed installation page 35

# NXT20

## Door- or wall-mount air conditioners

COOLING CAPACITY 2000 W

### DIMENSIONS

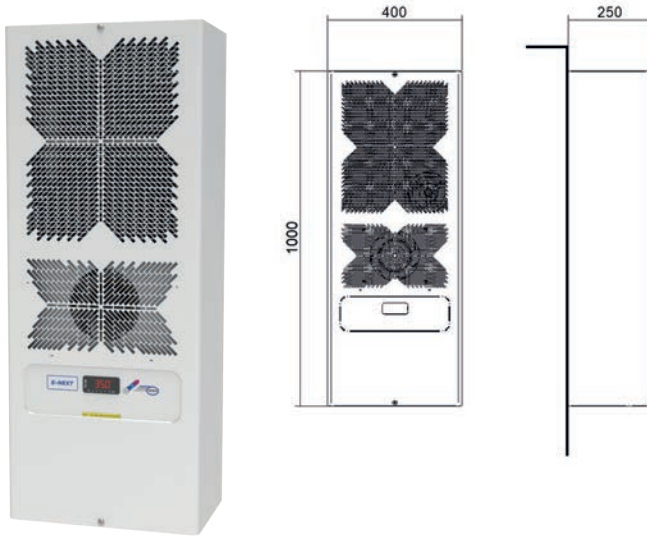

### PERFORMANCE

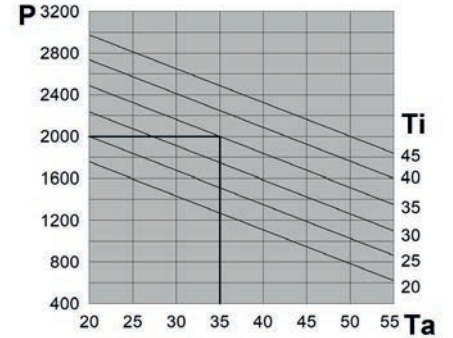

- P = Cooling capacity (W)
- Ta = Ambient Temperature (°C)
- Ti = Internal cabinet temperature (°C)

Features	UoM	NXT20B0E1C00000	NXT20H0E1C00000	NXT20B0E1U00000	NXT20C0E1U00000	NXT20H0E1U00000	NXT20V0E1C00000	
Cooling capacity EN14511 - A35A35	W	2000	2000	2000	2000	2000	2000	
Cooling capacity EN14511 - A35A50	W	1500	1500	1500	1500	1500	1500	
Power supply	V - Hz	230 - 1 - 50/60	400/3/50 460/3/60	230 - 1 - 50/60	115 - 1 - 60	400/3/50 460/3/60	48VDC	
Width - Height - Depth	mm	400 - 1000 - 250	400 - 1000 - 250	400 - 1000 - 250	400 - 1000 - 250	400 - 1000 - 250	400 - 1000 - 250	
Max current	A	4.8	1.6	4.8	11.3	1.6	21	
Inrush current	A	21.8	12	21.8	56.8	12	-	
T Fuse	A	10	4	10	16	4	26	
Power draw EN14511 - A35A35	W	990	870	990	1170	870	890	
Power draw EN14511 -A35A50	W	1130	1050	1130	1360	1050	1030	
Electrical connection	-	4-pin plug	4-pin plug	4-pin plug	4-pin plug	4-pin plug	4-pin plug	
Cabinet air fan capacity	m <sup>3</sup> /h	540	540	540	540	540	540	
Internal temperature range	°C	20-45	20-45	20-45	20-45	20-45	20-45	
Temperature regulation	-	Electronic thermostat TX-i40 factory set to 35°C						Mech. thermostat
External temperature range	°C	20-55	20-55	20-55	20-55	20-55	20-55	
Ingress protection - cabinet side	-	IP55	IP55	NEMA TYPE 12	NEMA TYPE 12	NEMA TYPE 12	IP55	
Noise level	dB (A)	65	65	65	65	65	65	
Weight	kg	42	44	42	42	44	42	
Conformity	-	CE UK CA	CE UK CA	UL CE UK CA	UL CE UK CA	UL CE UK CA	CE UK CA	

Version for semi-recessed installation page 35

# NXT30

## Door- or wall-mount air conditioners

COOLING CAPACITY 3000 W

### DIMENSIONS

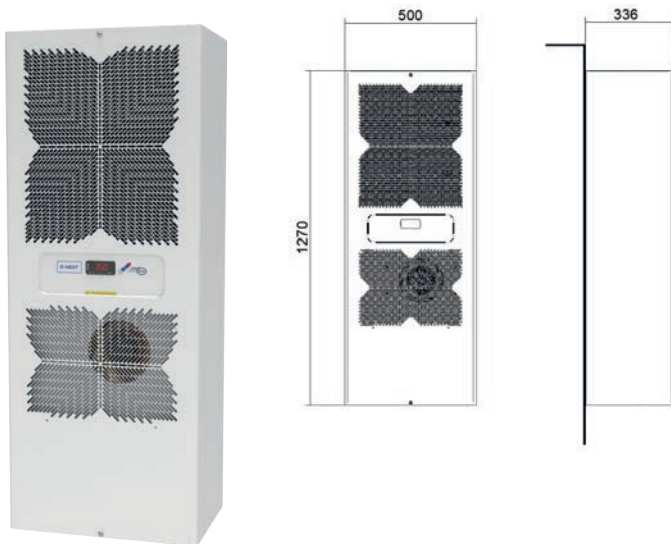

### PERFORMANCE

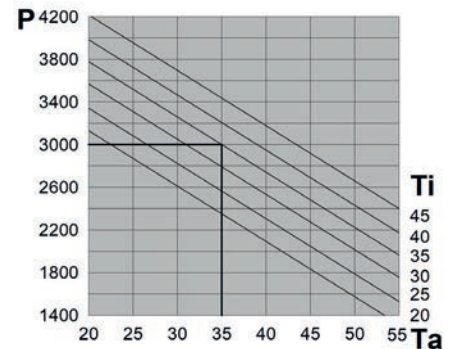

- P = Cooling capacity (W)
- Ta = Ambient Temperature (°C)
- Ti = Internal cabinet temperature (°C)

Features	UoM	NXT30B0E1C00000	NXT30H0E1C00000	NXT30B0E1U00000	NXT30H0E1U00000
Cooling capacity EN14511 - A35A35	W	3000	3000	3000	3000
Cooling capacity EN14511 - A35A50	W	2210	2210	2210	2210
Power supply	V ~ Hz	230 - 1 - 50/60	400/3/50 - 460/3/60	230 - 1 - 50/60	400/3/50 - 460/3/60
Width - Height - Depth	mm	500 - 1270 - 336	500 - 1270 - 336	500 - 1270 - 336	500 - 1270 - 336
Max current	A	5.2	2.4	5.2	2.4
Inrush current	A	35	20	35	20
T Fuse	A	10	6	10	6
Power draw EN14511 - A35A35	W	1190	1140	1190	1140
Power draw EN14511 - A35A50	W	1380	1350	1380	1350
Electrical connection	-	4-pin plug	4-pin plug	4-pin plug	4-pin plug
Cabinet air fan capacity	m <sup>3</sup> /h	1500	1500	1500	1500
Internal temperature range	°C	20-45	20-45	20-45	20-45
Temperature regulation	-	Electronic thermostat TX-i40 factory set to 35°C			
External temperature range	°C	20-55	20-55	20-55	20-55
Ingress protection - cabinet side	-	IP55	IP55	NEMA TYPE 12	NEMA TYPE 12
Noise level	dB (A)	70	70	70	70
Weight	kg	66	70	66	70
Conformity	-	CE UK CA	CE UK CA	UL CE UK CA	UL CE UK CA

# NXT40

## Door- or wall-mount air conditioners

COOLING CAPACITY **3850 W**

### DIMENSIONS

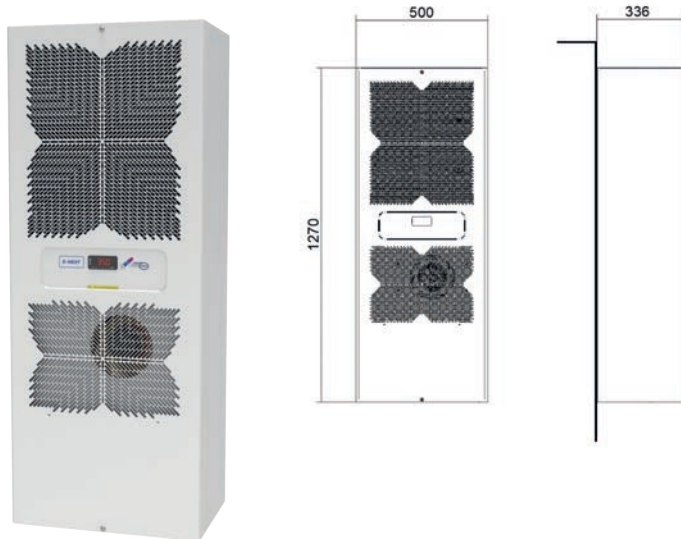

### PERFORMANCE

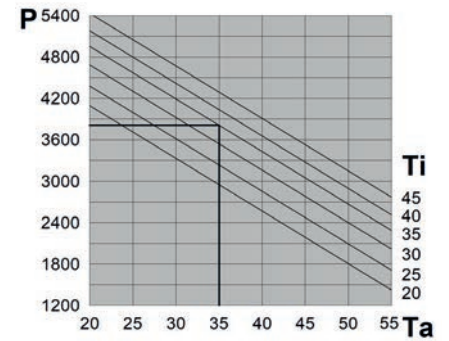

- P = Cooling capacity (W)
- Ta = Ambient Temperature (°C)
- Ti = Internal cabinet temperature (°C)

Features	UoM	NXT40B0E1C00000	NXT40H0E1C00000	NXT40B0E1U00000	NXT40H0E1U00000
Cooling capacity EN14511 - A35A35	W	3850	3850	3850	3850
Cooling capacity EN14511 - A35A50	W	2650	2650	2650	2650
Power supply	V ~ Hz	230 - 1 - 50/60	400/3/50 - 460/3/60	230 - 1 - 50/60	400/3/50 - 460/3/60
Width - Height - Depth	mm	500 - 1270 - 336	500 - 1270 - 336	500 - 1270 - 336	500 - 1270 - 336
Max current	A	7.8	3.1	7.8	3.6
Inrush current	A	37	16	37	18
T Fuse	A	16	6	16	8
Power draw EN14511 - A35A35	W	1670	1580	1670	1780
Power draw EN14511 -A35A50	W	1980	1920	1980	2050
Electrical connection	-	4-pin plug	4-pin plug	4-pin plug	4-pin plug
Cabinet air fan capacity	m <sup>3</sup> /h	1500	1500	1500	1500
Internal temperature range	°C	20-45	20-45	20-45	20-45
Temperature regulation	-	Electronic thermostat TX-i40 factory set to 35°C			
External temperature range	°C	20-55	20-55	20-55	20-55
Ingress protection - cabinet side	-	IP55	IP55	NEMA TYPE 12	NEMA TYPE 12
Noise level	dB (A)	70	70	70	70
Weight	kg	70	74	70	74
Conformity	-	CE UK CA	CE UK CA	UL CE UK CA	UL CE UK CA

# NXT60

## Door- or wall-mount air conditioners

COOLING CAPACITY

5400 W

### DIMENSIONS

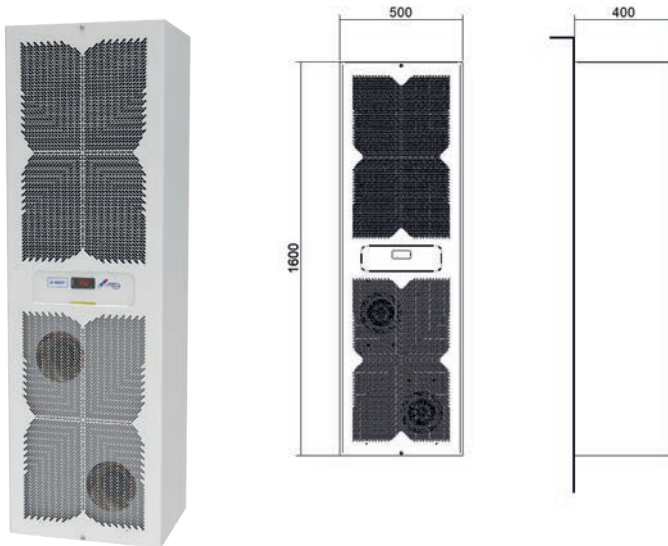

### PERFORMANCE

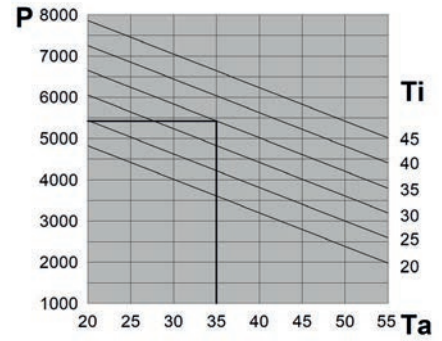

- P = Cooling capacity (W)
- Ta = Ambient Temperature (°C)
- Ti = Internal cabinet temperature (°C)

Features	UoM	NXT60H0E1C00000	NXT60H0E1U00000
Cooling capacity EN14511 - A35A35	W	5400	5400
Cooling capacity EN14511 - A35A50	W	4200	4200
Power supply	V ~ Hz	400/3/50 - 460/3/60	400/3/50 - 460/3/60
Width - Height - Depth	mm	500 - 1600 - 400	500 - 1600 - 400
Max current	A	3.7	3.7
Inrush current	A	32	32
T Fuse	A	8	8
Power draw EN14511 - A35A35	W	1950	1950
Power draw EN14511 -A35A50	W	2470	2470
Electrical connection	-	4-pin plug	4-pin plug
Cabinet air fan capacity	m <sup>3</sup> /h	1500	1500
Internal temperature range	°C	20-45	20-45
Temperature regulation	-	Electronic thermostat TX-i40 factory set to 35°C	
External temperature range	°C	20-55	20-55
Ingress protection - cabinet side	-	IP55	NEMA TYPE 12
Noise level	dB (A)	72	72
Weight	kg	104	104
Conformity	-	CE UK EAC	CE UK EAC

# ACCESSORIES

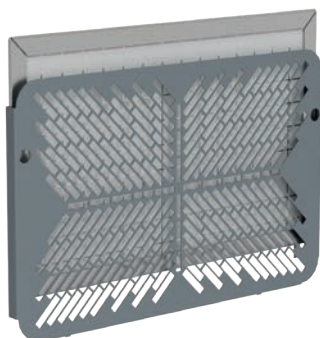

Models	Item code
NXT04	C15W00139
NXT06/08	C15W00140
NXT10	C15W00141
NXT12/16/20	C15W00142
NXT30/40	C15W00143
NXT60	C15W00144

As a separately sold accessory, the E-next range includes **magnetic filter support** in RAL 7011 and related filter. This accessory comes in handy in demanding applications where frequent servicing is required. The NEN polypropylene filter on aluminium frame allows for fast cleaning and the washable filter can be used repeatedly.

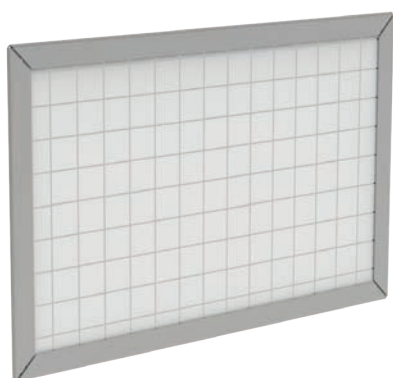

Models	Item code
NXT04	C15007976
NXT06/08	C15007968
NXT10	C15007972
NXT12/16/20	C15007973
NXT30/40	C15007974
NXT60	C15007975

\* NXT04 polyurethane air filter

**NEN-type replacement filter** with aluminium frame for E-NEXT range of air conditioners; filter-holding frame not included.





Models	Item code
All models	C12007176

The condensate **collection bottle** developed by **texa industries** makes it possible to collect the excess condensate from the air conditioner. This accessory is required where no drain is available in the vicinity and you prefer not having water sitting at the base of the panel. The bottle is made of plastic and is supplied with anodised aluminium mount.



Models	Item code
All models except NXT04	C16W00024

The 5-metre-long **sequence cable** lets you interface two E-NEXT air conditioners installed in the same cabinet; the two units will communicate with each other thanks to the TX-i40 controller, allowing perfect thermal management of the electric cabinet.

# ACCESSORIES



Models	Item code
NXT04	C12X00454
NXT06/08	C12X00455
NXT10	C12X00456
NXT12/16/20	C12X00457
NXT30/40/60	C12X00458

**Diverters** installed at the air outlet in the cabinet are an effective way to avoid cold air short circuits in the cabinet. These are required when installed components in the electrical cabinet prevent good air circulation.

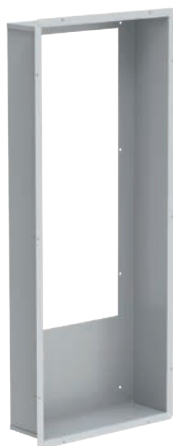

Models	Item code	Recessed
NXT30/40	C12X00439	170mm
NXT60	C12X00440	150mm

**Semi-recessed frames** available for NXT30/40/60 are ideal to reduce the external footprint of the air conditioner by partially recessing it into the cabinet. They are also useful for door installation, to avoid putting excessive strain on cabinet hinges.

# OPTIONS

## E-NEXT range, version for semi-recessed installation

**NXT04**  
DIMENSIONS

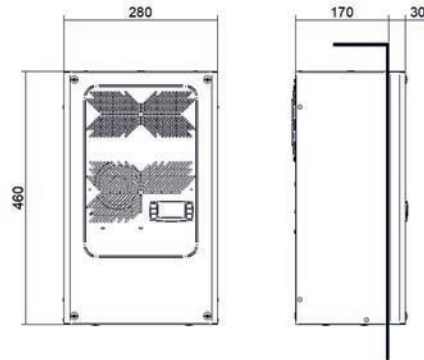

**NXT06-08**  
DIMENSIONS

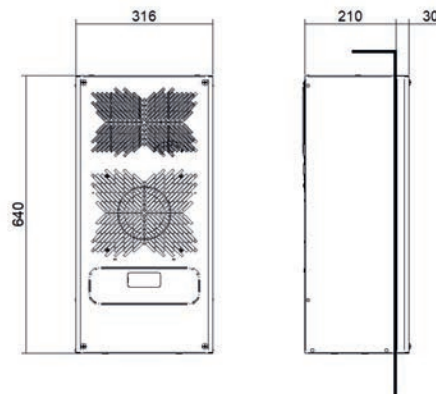

**NXT10**  
DIMENSIONS

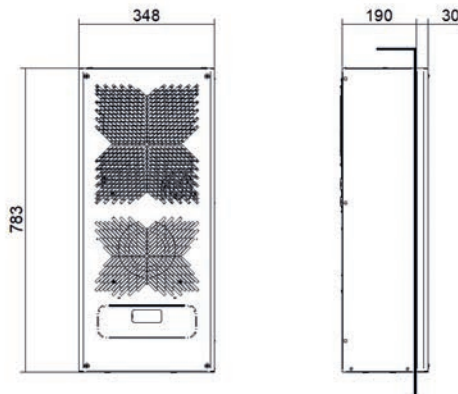

**NXT12-16-20**  
DIMENSIONS

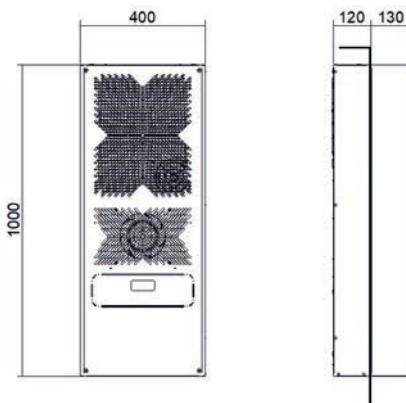

# FLY

## Door- or wall-mount air conditioners

A revolutionary installation system combined with an attractive design with significantly reduced depth make FLY air conditioners perfect for any automation panels.

### REFRIGERANT GAS

Air conditioners all come pre-charged with R134a refrigerant.

### WIDE RANGE OF POWER OUTPUTS

The available power outputs range from 1100 to 3200 W, covering most electrical cabinet cooling requirements in an extremely compact size.

### FLEXIBILITY OF INSTALLATION

The units can be installed outside the cabinet (external) or integrated (recessed or semi recessed), without the need for additional installation accessories. This feature leaves users free to choose the installation type without any restrictions. A SINGLE DRILLING TEMPLATE FOR THE WHOLE RANGE.

### ELECTRONIC REGULATION

All **texa industries** air conditioning systems are equipped with electronic regulation as standard.

### QUICK INSTALLATION

Installation is made quick by the simplicity of the drilling to be performed on the cabinet panel, and by the fastening systems, with all required elements included in the air conditioner package.

### REDUCED MAINTENANCE

All units are designed to prevent clogging by solid contaminants present in the air. The condensing coils are protected by a HYDROPHILIC TREATMENT which prevents dirt and corrosion.

### CONDENSATE DISSIPATOR

FLY air conditioners are equipped with an INTEGRATED CONDENSATE RECOVERY SYSTEM which allows installation costs to be further reduced.

### CERTIFICATIONS

All FLY models are CE and UL approved in standard supply voltages.



# FLY11

## Door- or wall-mount air conditioners

COOLING CAPACITY 1100 W

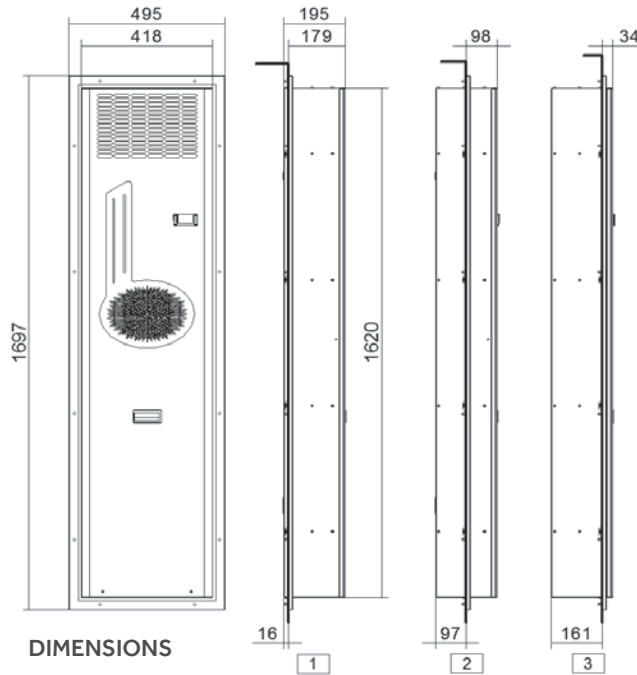

### PERFORMANCE

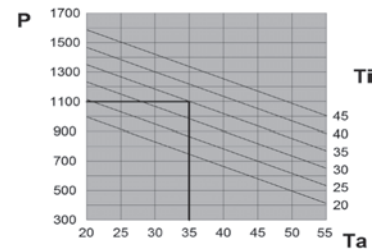

- P = Cooling capacity (W)
- Ta = Ambient Temperature (°C)
- Ti = Internal cabinet temperature (°C)

Features	UoM	FLY11BT0B	FLY11BTUB	FLY11KT0B	FLY11KTUB
Cooling capacity EN14511 - A35A35	W	1100	1100	1100	1100
Cooling capacity EN14511 - A35A50	W	860	860	860	860
Power supply	V - Hz	230 1~ 50-60	230 1~ 50-60	400/460 2~ 50-60	400/460 2~ 50-60
Width - Height - Depth	mm	495 - 1697 - 195	495 - 1697 - 195	495 - 1697 - 195	495 - 1697 - 195
Max current	A	6	6	3	3
Inrush current	A	21	21	8.5	8.5
T Fuse	A	10	10	5	5
Power draw EN14511 - A35A35	W	850	850	850	850
Power draw EN14511 -A35A50	W	980	980	980	980
Electrical connection	-	4-pin plug	4-pin plug	4-pin plug	4-pin plug
Cabinet air fan capacity	m <sup>3</sup> /h	860	860	860	860
Internal temperature range	°C	20-45	20-45	20-45	20-45
External temperature range	°C	20-55	20-55	20-55	20-55
EN60529 ingress protection - cabinet side	-	IP55	IP55	IP55	IP55
Noise level	dB (A)	64	64	64	64
Weight	kg	57	57	59	59
Conformity	-	CE	CE c RU US	CE	CE c RU US

# FLY15

## Door- or wall-mount air conditioners

COOLING CAPACITY 1500 W

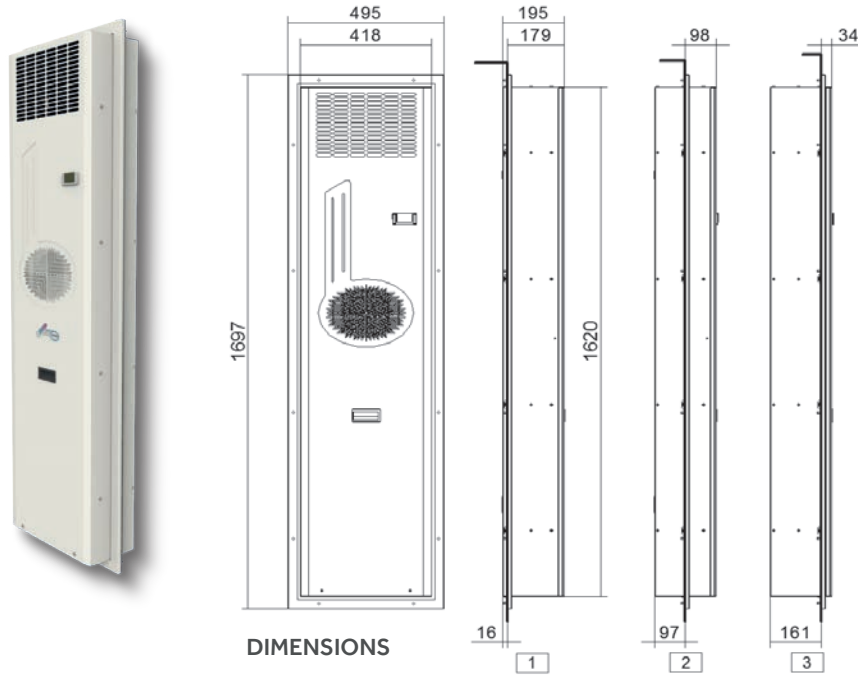

### PERFORMANCE

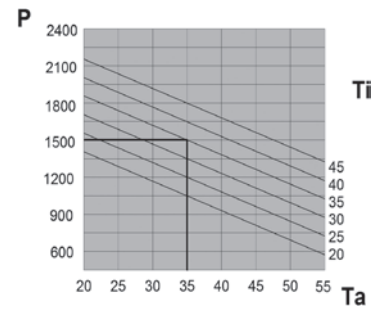

- P = Cooling capacity (W)
- Ta = Ambient Temperature (°C)
- Ti = Internal cabinet temperature (°C)

Features	UoM	FLY15BT0B	FLY15BTUB	FLY15KT0B	FLY15KTUB
Cooling capacity EN14511 - A35A35	W	1500	1500	1500	1500
Cooling capacity EN14511 - A35A50	W	1150	1150	1150	1150
Power supply	V ~ Hz	230 1~ 50-60	230 1~ 50-60	400/460 2~ 50-60	400/460 2~ 50-60
Width - Height - Depth	mm	495 - 1697 - 195	495 - 1697 - 195	495 - 1697 - 195	495 - 1697 - 195
Max current	A	6.3	6.3	3.5	3.5
Inrush current	A	24	24	10.5	10.5
T Fuse	A	10	10	6	6
Power draw EN14511 - A35A35	W	1020	1020	1020	1020
Power draw EN14511 -A35A50	W	1290	1290	1290	1290
Electrical connection	-	4-pin plug	4-pin plug	4-pin plug	4-pin plug
Cabinet air fan capacity	m <sup>3</sup> /h	860	860	860	860
Internal temperature range	°C	20-45	20-45	20-45	20-45
External temperature range	°C	20-55	20-55	20-55	20-55
EN60529 ingress protection - cabinet side	-	IP55	IP55	IP55	IP55
Noise level	dB (A)	66	66	66	66
Weight	kg	59	59	61	61
Conformity	-	CE	CE	CE	CE

# FLY20

## Door- or wall-mount air conditioners

COOLING CAPACITY 2000 W

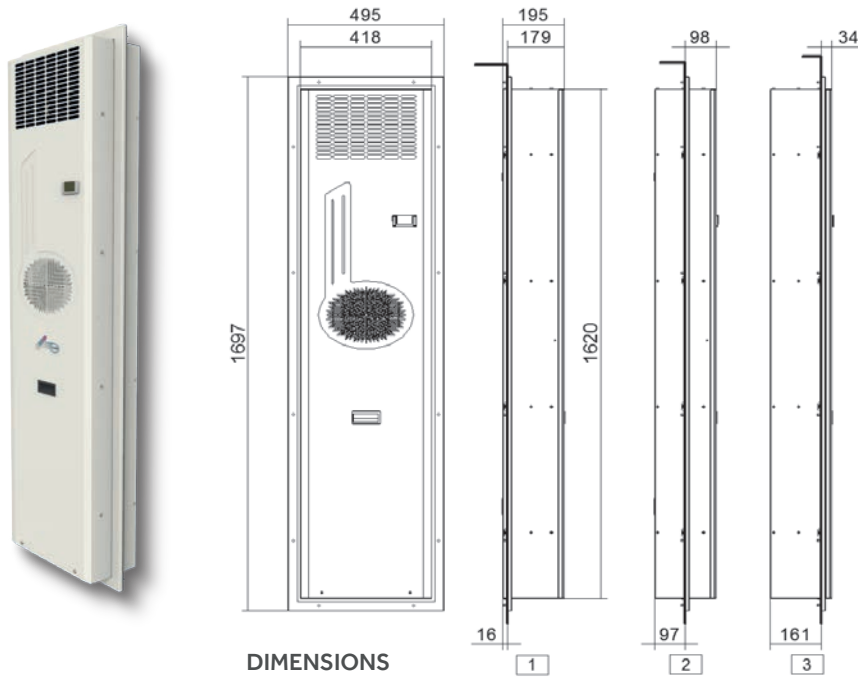

### PERFORMANCE

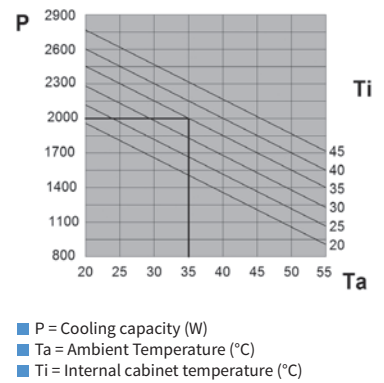

Features	UoM	FLY20BT0B	FLY20BTUB	FLY20HT0B	FLY20HTUB
Cooling capacity EN14511 - A35A35	W	2000	2000	2000	2000
Cooling capacity EN14511 - A35A50	W	1550	1550	1550	1550
Power supply	V ~ Hz	230 1~ 50-60	230 1~ 50-60	400 3~ 50/460 3~ 60	400 3~ 50/460 3~ 60
Width - Height - Depth	mm	495 - 1697 - 195	495 - 1697 - 195	495 - 1697 - 195	495 - 1697 - 195
Max current	A	6.5	6.5	3	3
Inrush current	A	27	27	10	10
T Fuse	A	11	11	6	6
Power draw EN14511 - A35A35	W	1290	1290	1410	1410
Power draw EN14511 -A35A50	W	1520	1520	1620	1620
Electrical connection	-	4-pin plug	4-pin plug	4-pin plug	4-pin plug
Cabinet air fan capacity	m <sup>3</sup> /h	860	860	860	860
Internal temperature range	°C	20-45	20-45	20-45	20-45
External temperature range	°C	20-55	20-55	20-55	20-55
EN60529 ingress protection - cabinet side	-	IP55	IP55	IP55	IP55
Noise level	dB (A)	67	67	67	67
Weight	kg	67	67	69	69
Conformity	-	CE	CE cRUUS	CE	CE cRUUS



# FLY25

## Door- or wall-mount air conditioners

COOLING CAPACITY 2500 W

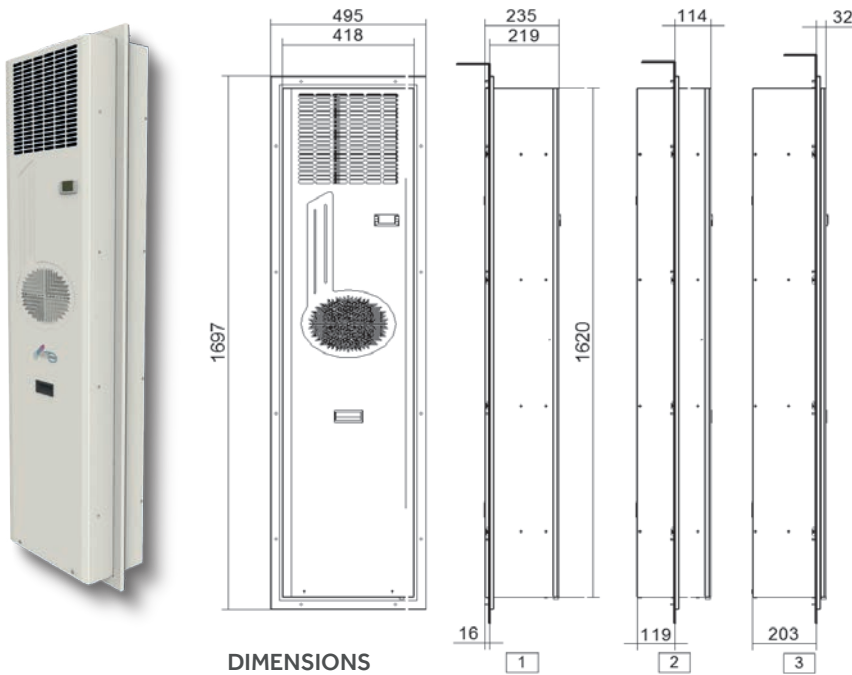

### PERFORMANCE

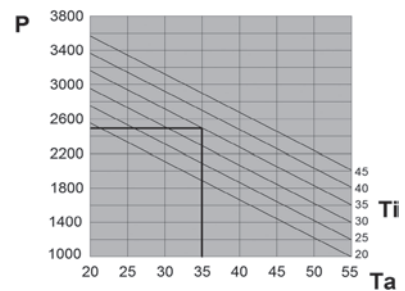

- P = Cooling capacity (W)
- Ta = Ambient Temperature (°C)
- Ti = Internal cabinet temperature (°C)

Features	UoM	FLY25BT0B	FLY25BTUB	FLY25HT0B	FLY25HTUB
Cooling capacity EN14511 - A35A35	W	2500	2500	2500	2500
Cooling capacity EN14511 - A35A50	W	1850	1850	1850	1850
Power supply	V ~ Hz	230 1~ 50-60	230 1~ 50-60	400 3~ 50/460 3~ 60	400 3~ 50/460 3~ 60
Width - Height - Depth	mm	495 - 1697 - 235	495 - 1697 - 235	495 - 1697 - 235	495 - 1697 - 235
Max current	A	10.5	10.5	3.5	3.5
Inrush current	A	35	35	14	14
T Fuse	A	13	13	7	7
Power draw EN14511 - A35A35	W	1640	1640	1690	1690
Power draw EN14511 - A35A50	W	1830	1830	1860	1860
Electrical connection	-	4-pin plug	4-pin plug	4-pin plug	4-pin plug
Cabinet air fan capacity	m <sup>3</sup> /h	1450	1450	1450	1450
Internal temperature range	°C	20-45	20-45	20-45	20-45
External temperature range	°C	20-55	20-55	20-55	20-55
EN60529 ingress protection - cabinet side	-	IP55	IP55	IP55	IP55
Noise level	dB (A)	69	69	69	69
Weight	kg	80	80	82	82
Conformity	-	CE	CE cRU <sub>US</sub>	CE	CE cRU <sub>US</sub>

# FLY32

## Door- or wall-mount air conditioners

COOLING CAPACITY 3200 W

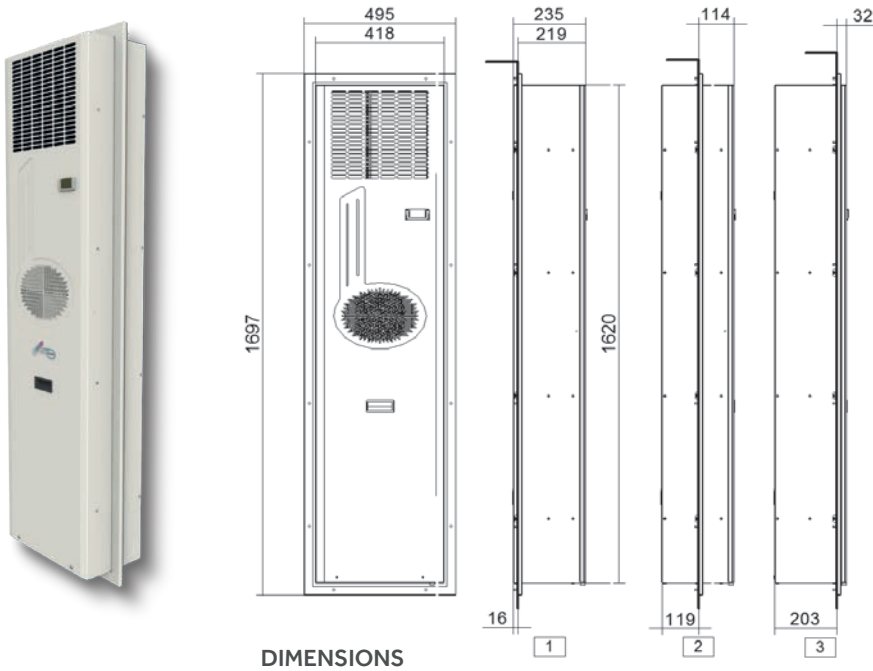

### PERFORMANCE

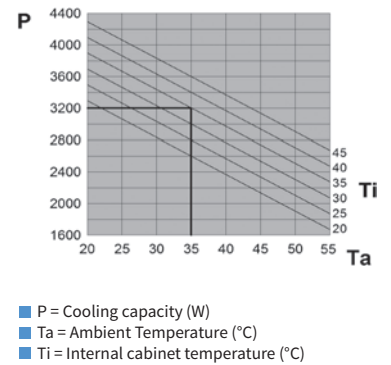

Features	UoM	FLY32BT0B	FLY32BTUB	FLY32HT0B	FLY32HTUB
Cooling capacity EN14511 - A35A35	W	3200	3200	3200	3200
Cooling capacity EN14511 - A35A50	W	2500	2500	2500	2500
Power supply	V ~ Hz	230 1~ 50-60	230 1~ 50-60	400 3~ 50/460 3~ 60	400 3~ 50/460 3~ 60
Width - Height - Depth	mm	495 - 1697 - 235	495 - 1697 - 235	495 - 1697 - 235	495 - 1697 - 235
Max current	A	12	12	4.5	4.5
Inrush current	A	39	39	18	18
T Fuse	A	15	15	8	8
Power draw EN14511 - A35A35	W	1920	1920	1980	1980
Power draw EN14511 -A35A50	W	2240	2240	2290	2290
Electrical connection	-	4-pin plug	4-pin plug	4-pin plug	4-pin plug
Cabinet air fan capacity	m <sup>3</sup> /h	1450	1450	1450	1450
Internal temperature range	°C	20-45	20-45	20-45	20-45
External temperature range	°C	20-55	20-55	20-55	20-55
EN60529 ingress protection - cabinet side	-	IP55	IP55	IP55	IP55
Noise level	dB (A)	69	69	69	69
Weight	kg	81	81	83	83
Conformity	-	CE	CE	CE	CE



# EGO

## Door- or wall-mount air conditioners

### ELECTRONIC REGULATION

All **texa industries** air conditioning systems are equipped with electronic regulation as standard.

### QUICK INSTALLATION

Installation is made quick by the simplicity of the drilling to be performed on the cabinet panel, and by the fastening systems.

### REDUCED MAINTENANCE

All units are designed to prevent clogging by solid contaminants present in the ambient air. The condensing coils are protected by a hydrophilic treatment which prevents dirt and corrosion.



# EGOS3

## Door- or wall-mount air conditioners

COOLING CAPACITY 300 W



Features	UoM	EGOS3BT1B
Cooling capacity EN14511 - A35A35	W	300
Cooling capacity EN14511 - A35A50	W	150
Power supply	V ~ Hz	230 1~ 50-60
Width - Height - Depth	mm	525 - 345 - 136
Max current	A	1.5
Inrush current	A	4.2
T Fuse	A	4
Power draw EN14511 - A35A35	W	270
Power draw EN14511 - A35A50	W	310
Electrical connection	-	4-pin plug
R134a Refrigerant	kg	0.12
Cabinet air fan capacity	m <sup>3</sup> /h	280
Internal temperature range	°C	20-45
Temperature regulation	-	Electronic thermostat TX050, factory set to 35°C
External temperature range	°C	20-55*
EN60529 ingress protection - cabinet side	-	IP55
Noise level	dB (A)	61
Weight	kg	14
Conformity	-	CE

\* 50 °C at 60 Hz

### PERFORMANCE

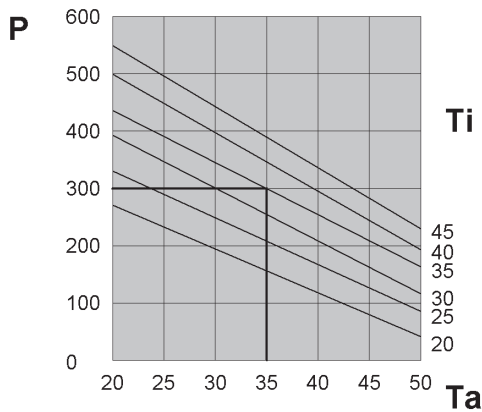

- P = Cooling capacity (W)
- Ta = Ambient Temperature (°C)
- Ti = Internal cabinet temperature (°C)

### DIMENSIONS

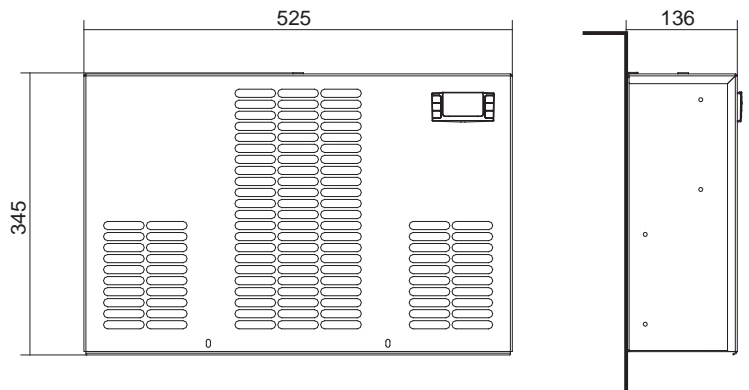

# EGO60

## Door- or wall-mount air conditioners

COOLING CAPACITY 5800 - 6050 W



Features	UoM	EGO60MTEB	EGO60NTEB
Cooling capacity EN14511 - A35A35	W	5800	6050
Cooling capacity EN14511 - A35A50	W	4350	4530
Power supply	V ~ Hz	400 3~ 50	460 3- 60
Width - Height - Depth	mm	600 - 2000 - 387	600 - 2000 - 387
Max current	A	5.9	6.8
Inrush current	A	21.7	23.5
T Fuse	A	8	8
Power draw EN14511 - A35A35	W	2340	2920
Power draw EN14511 - A35A50	W	3880	4520
Electrical connection	-	Cable L = 3 m	Cable L = 3 m
R407C Refrigerant	kg	1.8	1.8
Cabinet air fan capacity	m <sup>3</sup> /h	1450	1450
Internal temperature range	°C	20-45	20-45
Temperature regulation	-	Electronic thermostat TX050, factory set to 35°C	
External temperature range	°C	20-50	20-50
EN60529 ingress protection - cabinet side	-	IP54	IP54
Noise level	dB (A)	72	72
Weight	kg	150	150
Conformity	-	CE	CE

### PERFORMANCE (EGO60MTEB)

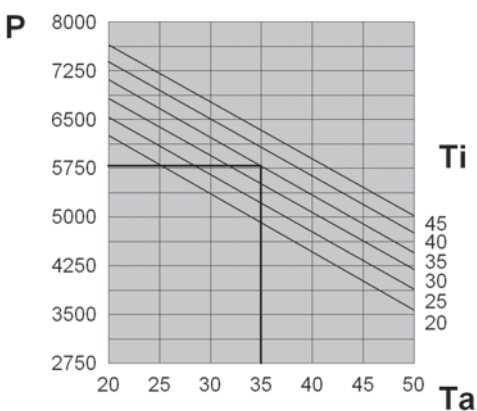

- P = Cooling capacity (W)
- Ta = Ambient Temperature (°C)
- Ti = Internal cabinet temperature (°C)

### DIMENSIONS

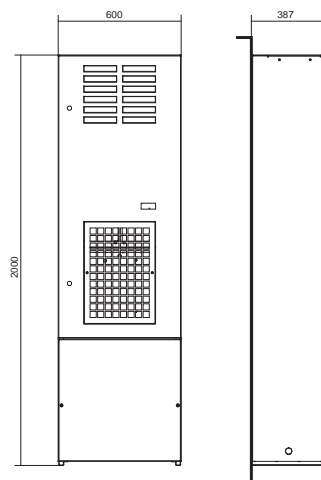

# EGO80

## Door- or wall-mount air conditioners

COOLING CAPACITY 7600 - 7950 W



Features	UoM	EGO80MTEB	EGO80NTEB
Cooling capacity EN14511 - A35A35	W	7600	7950
Cooling capacity EN14511 - A35A50	W	5700	5930
Power supply	V ~ Hz	400 3 - 50	460 3 - 60
Width - Height - Depth	mm	800 - 2000 - 387	800 - 2000 - 387
Max current	A	8.1	9.3
Inrush current	A	30.7	32.5
T Fuse	A	16	16
Power draw EN14511 - A35A35	W	3300	4035
Power draw EN14511 - A35A50	W	4910	5845
Electrical connection	-	Cable L = 3 m	Cable L = 3 m
R134a Refrigerant	kg	2.8	2.8
Cabinet air fan capacity	m <sup>3</sup> /h	2900	2900
Internal temperature range	°C	20-45	20-45
Temperature regulation	-	Electronic thermostat TX050, factory set to 35°C	
External temperature range	°C	20-50	20-50
EN60529 ingress protection - cabinet side		IP54	IP54
Noise level	dB (A)	75	75
Weight	kg	160	160
Conformity	-	CE	CE

### PERFORMANCE (EGO80MTEB)

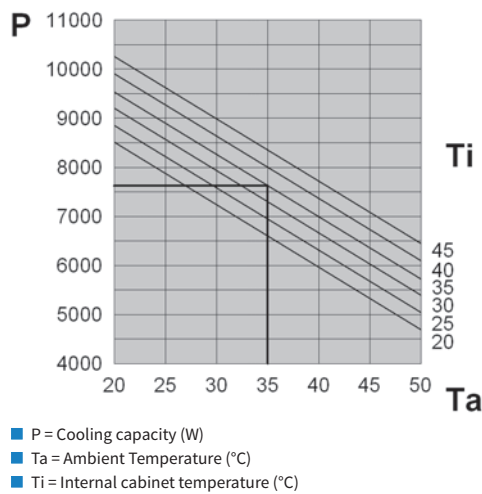

### DIMENSIONS

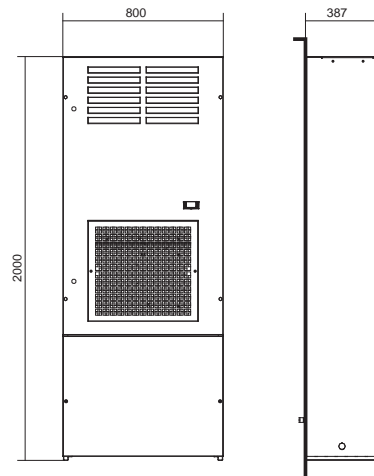



# EGOA0

## Door- or wall-mount air conditioners

COOLING CAPACITY 9400 - 9850 W



Features	UoM	EGOA0MTEB	EGOA0NTEB
Cooling capacity EN14511 - A35A35	W	9400	9850
Cooling capacity EN14511 - A35A50	W	7000	7350
Power supply	V ~ Hz	400 3~ 50	460 3~ 60
Width - Height - Depth	mm	800 - 2000 - 387	800 - 2000 - 387
Max current	A	9.1	10.3
Inrush current	A	30.7	32.5
T Fuse	A	18	18
Power draw EN14511 - A35A35	W	3650	4380
Power draw EN14511 - A35A50	W	5400	6340
Electrical connection	-	Cable L = 3 m	Cable L = 3 m
R134a Refrigerant	kg	2.3	2.3
Cabinet air fan capacity	m <sup>3</sup> /h	2900	2900
Internal temperature range	°C	20-45	20-45
Temperature regulation	-	Electronic thermostat, factory set to 35°C	
External temperature range	°C	20-50	20-50
EN60529 ingress protection - cabinet side	-	IP54	IP54
Noise level	dB (A)	77	77
Weight	kg	180	180
Conformity	-	CE	CE

### PERFORMANCE (EGOA0MTEB)

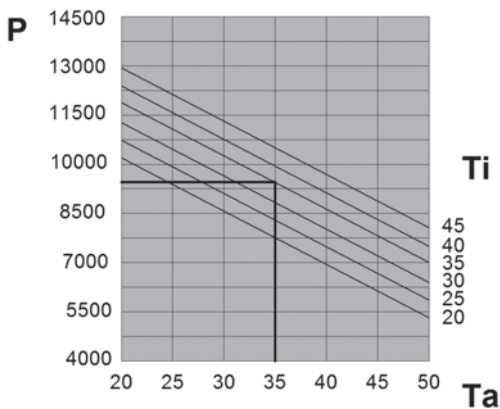

- P = Cooling capacity (W)
- Ta = Ambient Temperature (°C)
- Ti = Internal cabinet temperature (°C)

### DIMENSIONS

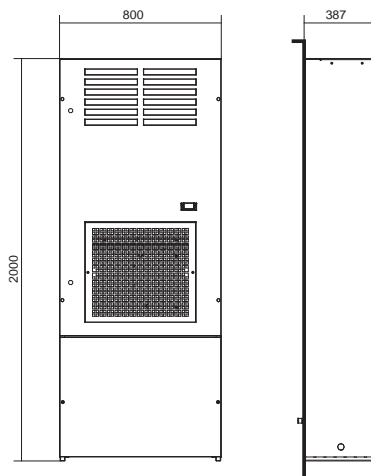

# EGOA5

## Door- or wall-mount air conditioners

**COOLING CAPACITY 14800 - 15150 W**



Features	UoM	EGOA5MTEB	EGOA5NTEB
Cooling capacity EN14511 - A35A35	W	14800	15150
Cooling capacity EN14511 - A35A50	W	11300	11600
Power supply	V ~ Hz	400 3~ 50	460 3~ 60
Width - Height - Depth	mm	800 - 2000 - 550	800 - 2000 - 550
Max current	A	11	11.8
Inrush current	A	49	51
T Fuse	A	20	20
Power draw EN14511 - A35A35	W	5750	6580
Power draw EN14511 - A35A50	W	6900	7760
Electrical connection	-	Cable L = 3 m	Cable L = 3 m
R410A Refrigerant	kg	3.5	3.5
Cabinet air fan capacity	m <sup>3</sup> /h	4300	4300
Internal temperature range	°C	20-45	20-45
Temperature regulation	-	Electronic thermostat, factory set to 35°C	
External temperature range	°C	20-50	20-50
EN60529 ingress protection - cabinet side	-	IP54	IP54
Noise level	dB (A)	67	67
Weight	kg	240	240
Conformity	-	CE	CE

### PERFORMANCE (EGOA5MTEB)

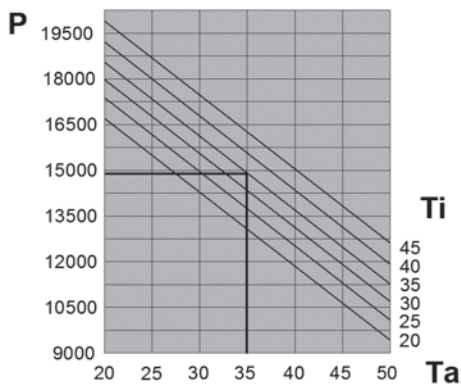

- P = Cooling capacity (W)
- Ta = Ambient Temperature (°C)
- Ti = Internal cabinet temperature (°C)

### DIMENSIONS

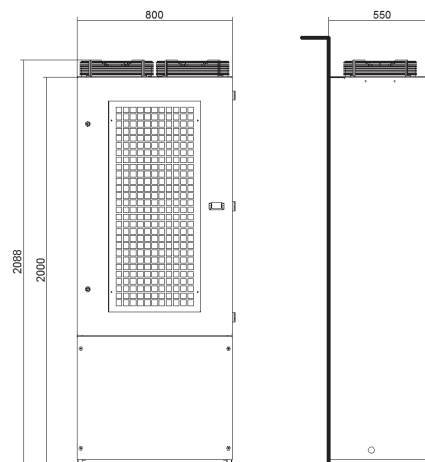

## FILTERS



Models	Item code	Quantity per pack
EGO60	C15000175	5
EGO80-A0	C15000188	5

### AAEFP/AADFP

#### PU foam filter for air conditioners

Texa industries **air conditioners** are designed not to require maintenance and are supplied without filters for the external air intake. However, when the ambient air is particularly contaminated by oily aerosols or particles, users can choose to insert a filter in the space provided at the rear of the intake grille. These filters are made from an alveolar polyurethane foam with highly stable mechanical and chemical properties.



Models	Item code	Quantity per pack
EGO60	C15000176	1
EGO80-A0	C15000189	1

### AAEFM/AADFM

#### Regenerable air filters for air conditioners

In extreme environmental conditions, the air conditioners can be fitted with metal air filters. They provide less efficient filtration than the PU foam filters, but have the advantage that they are regenerable. They can be cleaned with degreaser and reused as many times as the user wishes. They are made from an aluminium mesh.

# DEK

## Roof-mount air conditioners

### REFRIGERANT GAS

Air conditioners all come pre-charged with R134a refrigerant

### WIDE RANGE OF POWER OUTPUTS

The available power outputs range from 410 to 3850 W, covering most electrical cabinet cooling requirements in an extremely compact size.

### PROTECTION FROM CONDENSATE

Great attention has been paid to protecting the cabinet from condensate. Inside the air conditioner is a stainless-steel tray in which the condensate is collected, before being drained off through a service hose and second safety hose.

### ELECTRONIC REGULATION

All **texa industries** air conditioning systems are equipped with electronic regulation as standard.

### QUICK INSTALLATION

Installation is made quick by the simplicity of the drilling to be performed on the cabinet panel, and by the fastening systems.

### REDUCED MAINTENANCE

All units are designed to prevent clogging by solid contaminants present in the ambient air.



## Roof-mount air conditioners

COOLING CAPACITY 410 W

## PERFORMANCE

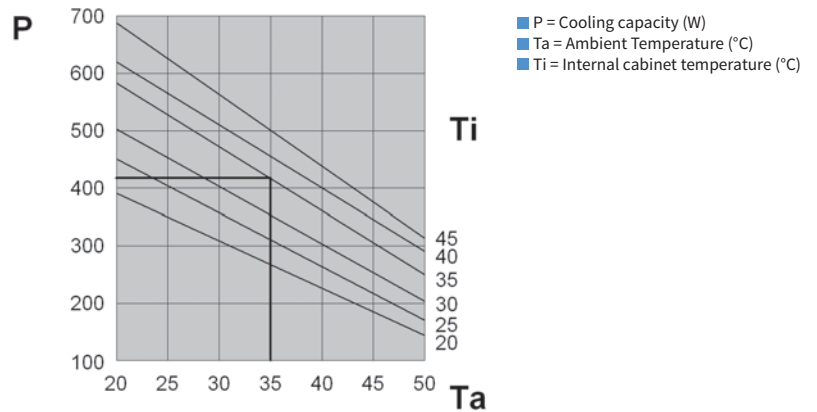
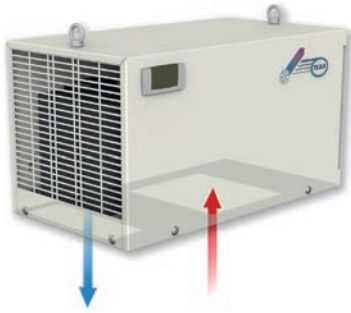

## DIMENSIONS

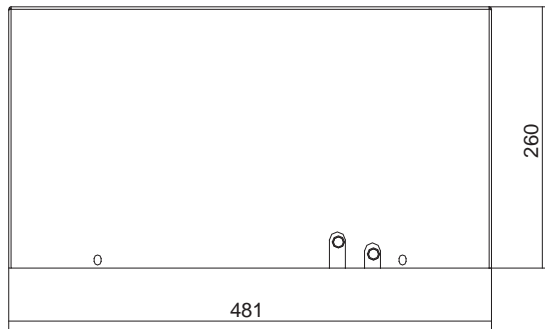
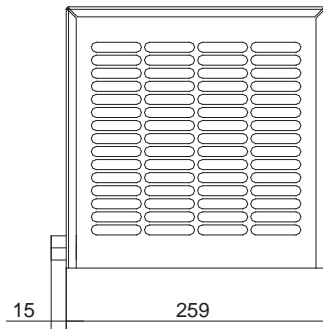

Features	UoM	DEK04BT0B	DEK04BTUB	DEK04CT0B
Cooling capacity EN14511 - A35A35	W	410	410	410
Cooling capacity EN14511 - A35A50	W	240	240	240
Power supply	V - Hz	230 1~ 50-60	230 1~ 50-60	115 1~ 50-60
Width - Height - Depth	mm	259 - 260 - 481	259 - 260 - 481	259 - 260 - 481
Max current	A	1.5	1.5	2.9
Inrush current	A	4	4	10
T Fuse	A	4	4	6
Power draw EN14511 - A35A35	W	230	230	280
Power draw EN14511 - A35A50	W	290	290	325
Electrical connection	-	4-pin plug	4-pin plug	4-pin plug
Cabinet air fan capacity	m <sup>3</sup> /h	235	235	235
Internal temperature range	°C	20-45	20-45	20-45
External temperature range	°C	20-55*	20-55*	20-50
EN60529 ingress protection - cabinet side	-	IP54	IP54	IP54
Noise level	dB (A)	60	65	60
Weight	kg	18	18	19
Conformity	-	CE	CE cULus	CE

\* 50 °C at 60 Hz

# DEK08

## Roof-mount air conditioners

COOLING CAPACITY 820 W

### PERFORMANCE

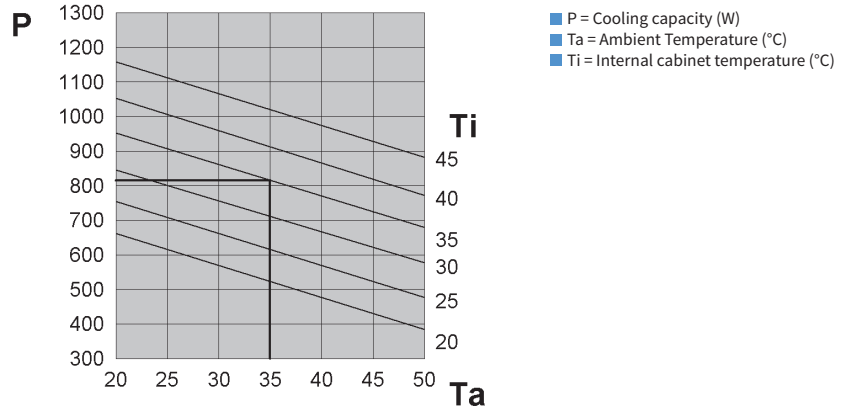

### DIMENSIONS

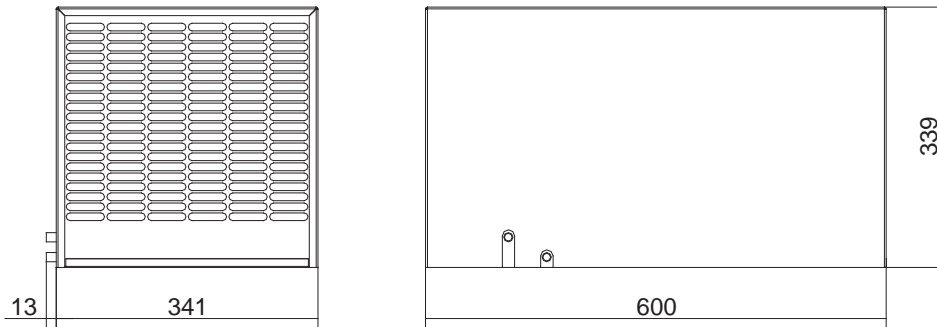

Features	UoM	DEK08BT0B	DEK08BTUB	DEK08CT0B	DEK08GT0B
Cooling capacity EN14511 - A35A35	W	820	820	820	820
Cooling capacity EN14511 - A35A50	W	680	680	680	680
Power supply	V ~ Hz	230 1~ 50-60	230 1~ 50-60	115 1~ 50-60	400/440 2~ 50-60
Width - Height - Depth	mm	341 - 339 - 600	341 - 339 - 600	341 - 339 - 600	341 - 339 - 600
Max current	A	2.9	3.5	5.7	1.7
Inrush current	A	12	12	19	7
T Fuse	A	6	6	10	4
Power draw EN14511 - A35A35	W	510	520	520	520
Power draw EN14511 -A35A50	W	560	590	570	570
Electrical connection	-	4-pin plug	4-pin plug	4-pin plug	4-pin plug
Cabinet air fan capacity	m <sup>3</sup> /h	570	570	570	570
Internal temperature range	°C	20-45	20-45	20-45	20-45
External temperature range	°C	20-55*	20-55*	20-50	20-50
EN60529 ingress protection - cabinet side	-	IP54	IP54	IP54	IP54
Noise level	dB (A)	62	65	62	62
Weight	kg	23	23	24	24
Conformity	-	CE	CE cULUS	CE	CE

\* 50 °C at 60 Hz

## Roof-mount air conditioners

COOLING CAPACITY 1150 W



## PERFORMANCE

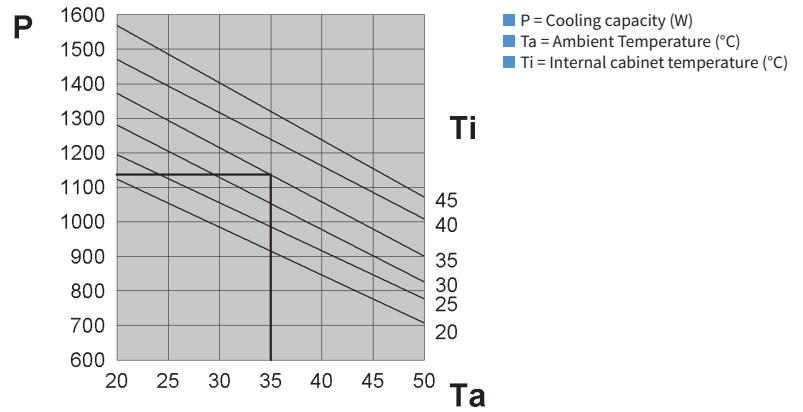

## DIMENSIONS

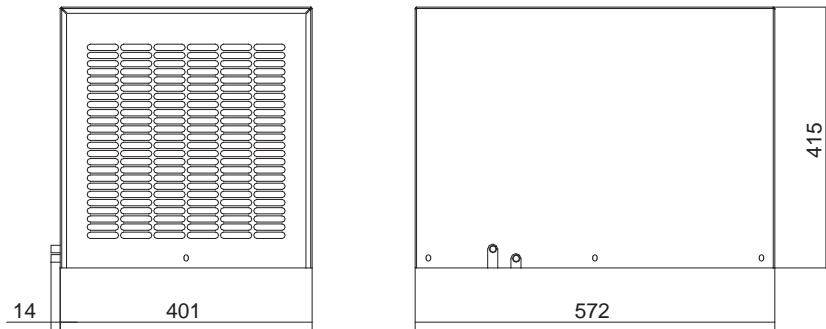

Features	UoM	DEK12BT0B	DEK12BTUB	DEK12CT0B	DEK12GT0B
Cooling capacity EN14511 - A35A35	W	1150	1150	1150	1150
Cooling capacity EN14511 - A35A50	W	900	900	900	900
Power supply	V ~ Hz	230 1~ 50-60	230 1~ 50-60	115 1~ 50-60	400/440 2~ 50-60
Width - Height - Depth	mm	401 - 415 - 572	401 - 415 - 572	401 - 415 - 572	401 - 415 - 572
Max current	A	3.2	4	6.4	2.2
Inrush current	A	11	11	22	8
T Fuse	A	6	6	12	6
Power draw EN14511 - A35A35	W	550	570	560	560
Power draw EN14511 -A35A50	W	660	690	670	670
Electrical connection	-	4-pin plug	4-pin plug	4-pin plug	4-pin plug
Cabinet air fan capacity	m <sup>3</sup> /h	570	570	570	570
Internal temperature range	°C	20-45	20-45	20-45	20-45
External temperature range	°C	20-55*	20-50	20-50	20-50
EN60529 ingress protection - cabinet side	-	IP54	IP54	IP54	IP54
Noise level	dB (A)	65	65	65	65
Weight	kg	40	40	42	42
Conformity	-	CE	CE cULus	CE	CE

\* 50 °C at 60 Hz



# DEK15

## Roof-mount air conditioners

COOLING CAPACITY 1550 W

### PERFORMANCE

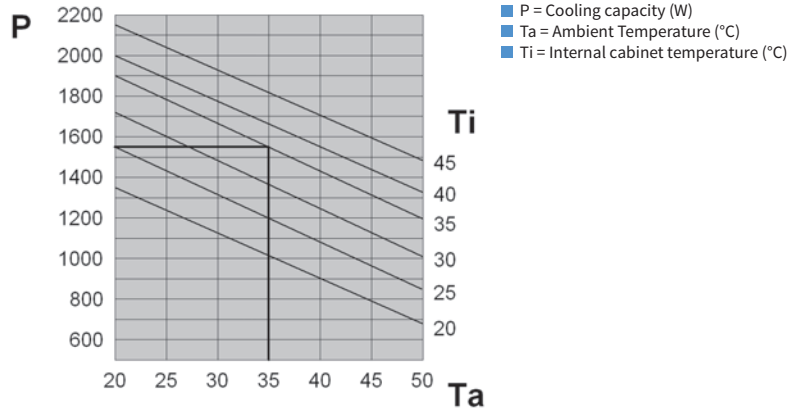

### DIMENSIONS

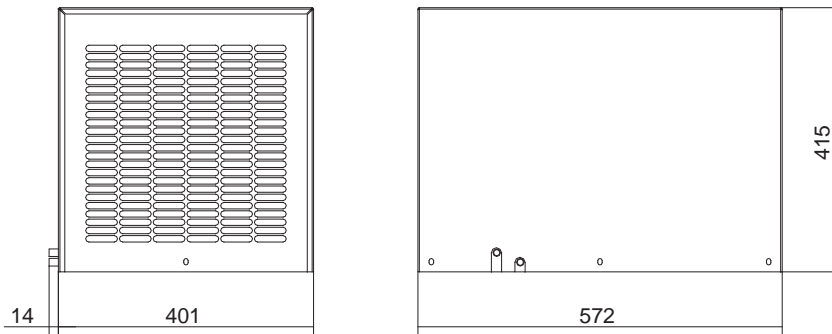

Features	UoM	DEK15BT0B	DEK15BTUB	DEK15CT0B	DEK15GT0B
Cooling capacity EN14511 - A35A35	W	1550	1550	1550	1550
Cooling capacity EN14511 - A35A50	W	1200	1200	1200	1200
Power supply	V ~ Hz	230 1~ 50-60	230 1~ 50-60	115 1~ 50-60	400/440 2~ 50-60
Width - Height - Depth	mm	401 - 415 - 572	401 - 415 - 572	401 - 415 - 572	401 - 415 - 572
Max current	A	4.5	5.5	10	2.8
Inrush current	A	18	18	39	9.6
T Fuse	A	8	10	18	6
Power draw EN14511 - A35A35	W	810	830	820	820
Power draw EN14511 - A35A50	W	930	960	940	940
Electrical connection	-	4-pin plug	4-pin plug	4-pin plug	4-pin plug
Cabinet air fan capacity	m <sup>3</sup> /h	860	860	860	860
Internal temperature range	°C	20-45	20-45	20-45	20-45
External temperature range	°C	20-55*	20-50	20-50	20-50
EN60529 ingress protection - cabinet side	-	IP54	IP54	IP54	IP54
Noise level	dB (A)	65	65	65	65
Weight	kg	44	44	46	46
Conformity	-	CE	CE cULus	CE	CE

\* 50 °C at 60 Hz

# DEK20

## Roof-mount air conditioners

COOLING CAPACITY 2050 W

### PERFORMANCE

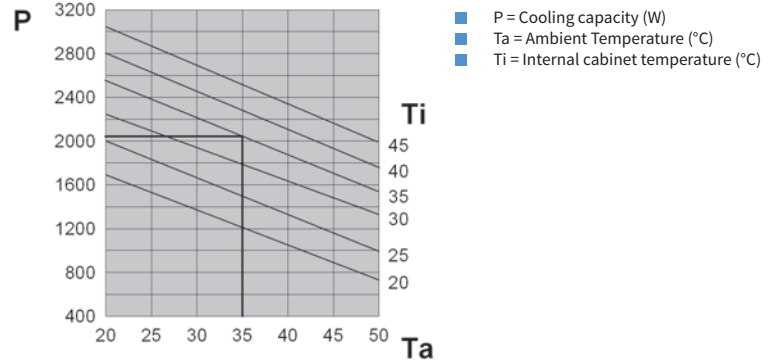

### DIMENSIONS

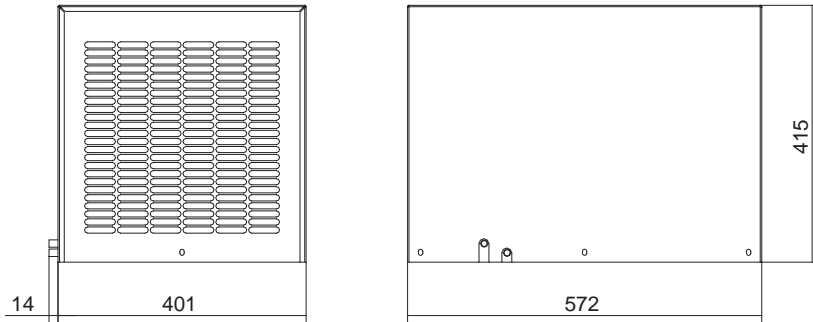

Features	UoM	DEK20BT0B	DEK20CT0B	DEK20LT0B	DEK20NTUB
Cooling capacity EN14511 - A35A35	W	2050	2050	2050	2050
Cooling capacity EN14511 - A35A50	W	1560	1560	1560	1560
Power supply	V ~ Hz	230 1~ 50-60	115 1~ 50-60	400 3~ 50-60	460 3~ 60
Width - Height - Depth	mm	401 - 415 - 572	401 - 415 - 572	401 - 415 - 572	401 - 415 - 572
Max current	A	6	13.2	1.9	2.1
Inrush current	A	24	48	10	10
T Fuse	A	10	20	4	6
Power draw EN14511 - A35A35	W	1150	1220	990	1060
Power draw EN14511 - A35A50	W	1250	1320	1190	1290
Electrical connection	-	4-pin plug	4-pin plug	4-pin plug	4-pin plug
Cabinet air fan capacity	m <sup>3</sup> /h	1050	1050	1050	1050
Internal temperature range	°C	20-45	20-45	20-45	20-45
External temperature range	°C	20-55*	20-50	20-50	20-50
EN60529 ingress protection - cabinet side	-	IP54	IP54	IP54	IP54
Noise level	dB (A)	65	65	65	65
Weight	kg	50	56	52	52
Conformity	-	CE	CE	CE	CE

\* 50 °C at 60 Hz

# DEK30

## Roof-mount air conditioners

COOLING CAPACITY 2900 W

### PERFORMANCE

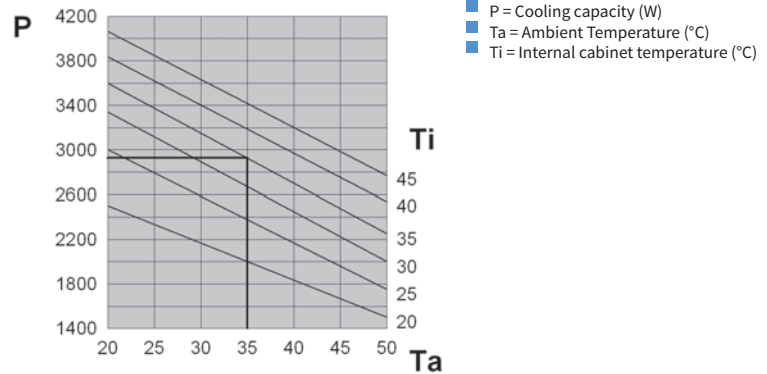

### DIMENSIONS

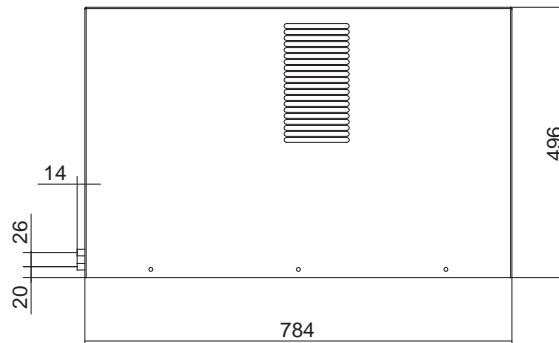
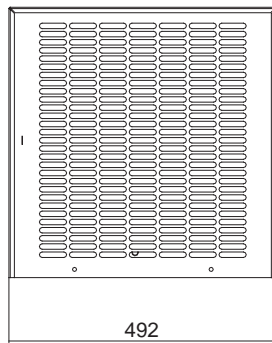

Features	UoM	DEK30BT0B	DEK30LT0B	DEK30NTUB
Cooling capacity EN14511 - A35A35	W	2900	2900	2900
Cooling capacity EN14511 - A35A50	W	2250	2250	2250
Power supply	V ~ Hz	230 1~ 50-60	400 3~ 50-60	460 3~ 60
Width - Height - Depth	mm	492 - 496 - 784	492 - 496 - 784	492 - 496 - 784
Max current	A	8.2	2.5	3.3
Inrush current	A	38.4	15.7	15.7
T Fuse	A	16	6	6
Power draw EN14511 - A35A35	W	1350	1210	1310
Power draw EN14511 -A35A50	W	1610	1450	1750
Electrical connection	-	4-pin plug	4-pin plug	4-pin plug
Cabinet air fan capacity	m <sup>3</sup> /h	860	860	860
Internal temperature range	°C	20-45	20-45	20-45
External temperature range	°C	20-50	20-50	20-50
EN60529 ingress protection - cabinet side	-	IP54	IP54	IP54
Noise level	dB (A)	75	75	75
Weight	kg	80	83	83
Conformity	-	CE	CE	CE cULus

# DEK40

## Roof-mount air conditioners

COOLING CAPACITY **3850 W**



### PERFORMANCE

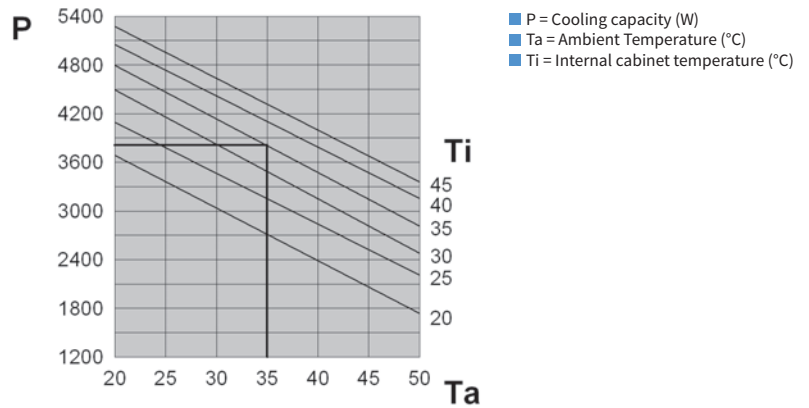

### DIMENSIONS

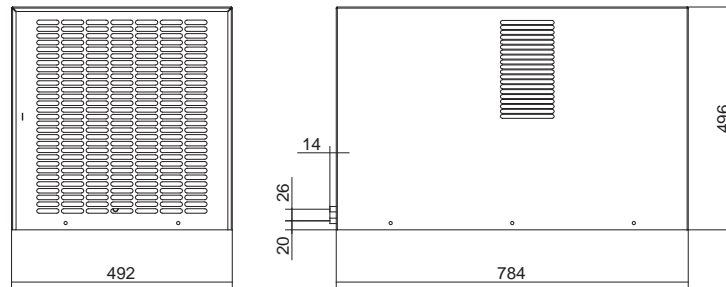

Features	UoM	DEK40BT0B	DEK40LT0B	DEK40NTUB
Cooling capacity EN14511 - A35A35	W	3850	3850	3850
Cooling capacity EN14511 - A35A50	W	2870	2870	2870
Power supply	V ~ Hz	230 1~ 50-60	400 3~ 50-60	460 3~ 60
Width - Height - Depth	mm	492 - 496 - 784	492 - 496 - 784	492 - 496 - 784
Max current	A	9	3.6	4.3
Inrush current	A	38.2	17	17
T Fuse	A	18	6	6
Power draw EN14511 - A35A35	W	1690	1790	1950
Power draw EN14511 - A35A50	W	1950	2010	2160
Electrical connection	-	4-pin plug	4-pin plug	4-pin plug
Cabinet air fan capacity	m <sup>3</sup> /h	1450	1450	1450
Internal temperature range	°C	20-45	20-45	20-45
External temperature range	°C	20-50	20-50	20-50
EN60529 ingress protection - cabinet side	-	IP54	IP54	IP54
Noise level	dB (A)	75	75	75
Weight	kg	83	86	86
Conformity	-	CE	CE	CE cULus

## FILTERS



Models	Item code	Quantity per pack
DEK04	C15000171	5
DEK08	C15000173	5
DEK12-15-20	AADFP12	5
DEK30-40	AADFP30	5

### AAEFP/AADFP

#### PU foam filter for air conditioners

Texa industries **air conditioners** are designed not to require maintenance and are supplied without filters for the external air intake. However, when the ambient air is particularly contaminated by oily aerosols or particles, users can choose to insert a filter in the space provided at the rear of the intake grille. These filters are made from an alveolar polyurethane foam with highly stable mechanical and chemical properties.



Models	Item code	Quantity per pack
DEK04	C15000172	1
DEK08	C15000174	1
DEK12-15-20	AADFM12	1
DEK30-40	AADFM30	1

### AAEFM/AADFM

#### Regenerable air filters for air conditioners

In extreme environmental conditions, the air conditioners can be fitted with metal air filters. They provide less efficient filtration than the PU foam filters, but have the advantage that they are regenerable. They can be cleaned with degreaser and reused as many times as the user wishes.

They are made from an aluminium mesh.

# NOX

## Wall-mount air conditioners for outdoor applications



### GAS

Air conditioners all come pre-charged with R134a refrigerant



### INTEGRATED MODBUS

All air conditioners with NOX-i40 can be provided with MODBUS RTU RS485 connection on request.



### ADVANCED SEQUENCING

All units are equipped with connection to sequence the operation of two air conditioners. This option allows back-up operation and distribution of operating hours.



### ADVANCED MICROPORT

Customers can easily program whether or not to lock the internal fan when the microport opens.



### ECO MODE

Standard feature on the entire range to optimise electricity use under low working load conditions.



### °C / °F

Change only one parameter to go from Celsius to Fahrenheit.



### PREDICTIVE MAINTENANCE

An advanced system enables the air conditioner to self-learn and alert the user when maintenance is due.



### SERVICE MODE

Runs a simple check procedure to ensure the air conditioner is working properly; useful during installation.



### HUMIDITY CONTROL

This option (supplied on request) uses a humidistat to control the humidity inside the cabinet; ideal for applications in tropical areas.

### EC EC FANS

Available on request, electronic fans increase air conditioner efficiency by further reducing energy consumption and related operating costs.



### LOW-NOISE VERSION

Available on request, the version with reduced modulated speed fans enables low-noise operation in outdoor residential or commercial applications.



# NOX06

## Wall-mount air conditioners for outdoor applications

COOLING CAPACITY

720 W

## DIMENSIONS

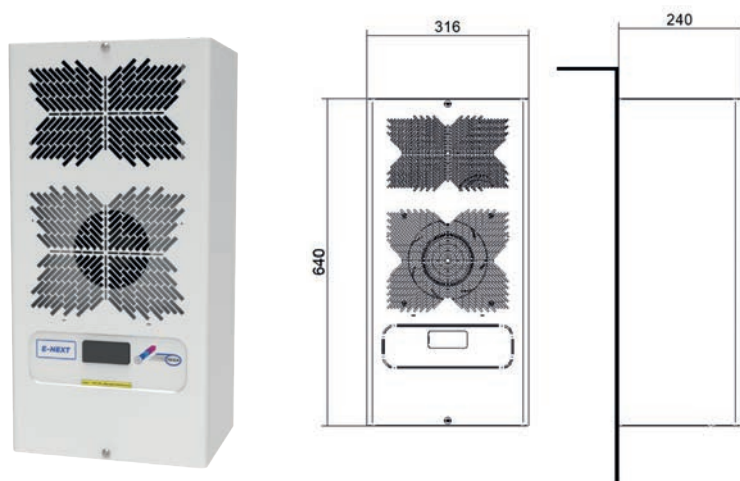

## PERFORMANCE

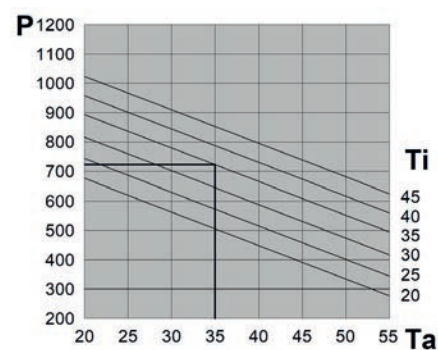

- P = Cooling capacity (W)
- Ta = Ambient Temperature (°C)
- Ti = Internal cabinet temperature (°C)

Features	UoM	NOX06B0E1C00000	NOX06K0E1C00000	NOX06B0E1U00000	NOX06C0E1U00000
Cooling capacity EN14511 - A35A35	W	720	720	720	720
Cooling capacity EN14511 - A35A50	W	555	555	555	555
Power supply	V ~ Hz	230 - 1 - 50/60	400/460 - 2 - 50/60	230 - 1 - 50/60	115 - 1 - 60
Width - Height - Depth	mm	316 - 640 - 240	316 - 640 - 240	316 - 640 - 240	316 - 640 - 240
Max current	A	2.3	1.3	2.3	4.3
Inrush current	A	10.9	6.3	10.9	22.2
T Fuse	A	6	4	6	8
Power draw EN14511 - A35A35	W	380	380	380	420
Power draw EN14511 - A35A50	W	450	450	450	500
Electrical connection	-	4-pin plug	4-pin plug	4-pin plug	4-pin plug
Cabinet air fan capacity	m <sup>3</sup> /h	305	305	305	305
Internal temperature range	°C	20-45	20-45	20-45	20-45
Temperature regulation	-	Electronic thermostat TX-i40 factory set to 35°C, with 3m cable and DIN rail installation kit			
External temperature range	°C	-20 - +55	-20 - +55	-20 - +55	-20 - +55
Ingress protection - cabinet side	-	IP55	IP55	NEMA TYPE 4/4X	NEMA TYPE 4/4X
Noise level	dB (A)	65	65	65	65
Weight	kg	24	26	24	24
Conformity	-	CE UK CA	CE UK CA	UL CE UK CA	UL CE UK CA

\* Type 4X only in stainless steel framework version



# NOX08

## Wall-mount air conditioners for outdoor applications

COOLING CAPACITY

880 W

### DIMENSIONS

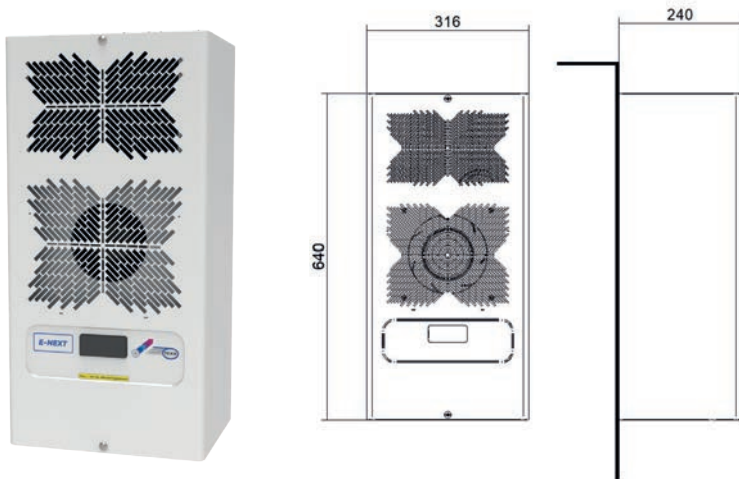

### PERFORMANCE

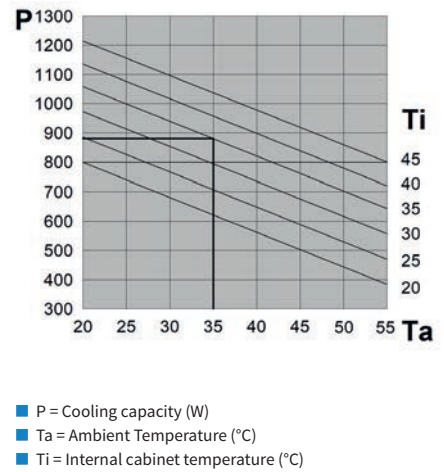

Features	UoM	NOX08B0E1C00000	NOX08K0E1C00000	NOX08B0E1U00000	NOX08C0E1U00000
Cooling capacity EN14511 - A35A35	W	880	880	880	880
Cooling capacity EN14511 - A35A50	W	705	705	705	705
Power supply	V ~ Hz	230 - 1 - 50/60	400/460 - 2 - 50/60	230 - 1 - 50/60	115 - 1 - 60
Width - Height - Depth	mm	316 - 640 - 240	316 - 640 - 240	316 - 640 - 240	316 - 640 - 240
Max current	A	2.4	1.4	2.4	4.2
Inrush current	A	12.9	7.4	12.9	22.2
T Fuse	A	6	4	6	8
Power draw EN14511 - A35A35	W	450	450	450	430
Power draw EN14511 -A35A50	W	520	520	520	540
Electrical connection	-	4-pin plug	4-pin plug	4-pin plug	4-pin plug
Cabinet air fan capacity	m <sup>3</sup> /h	325	325	325	325
Internal temperature range	°C	20-45	20-45	20-45	20-45
Temperature regulation	-	Electronic thermostat TX-i40 factory set to 35°C, with 3m cable and DIN rail installation kit			
External temperature range	°C	-20 - +55	-20 - +55	-20 - +55	-20 - +55
Ingress protection - cabinet side	-	IP55	IP55	NEMA TYPE 4/4X	NEMA TYPE 4/4X
Noise level	dB (A)	65	65	65	65
Weight	kg	25	27	25	25
Conformity	-	CE UK CA	CE UK CA	CE UK CA	CE UK CA

\* Type 4X only in stainless steel framework version

## Wall-mount air conditioners for outdoor applications

COOLING CAPACITY

1000 W

## DIMENSIONS

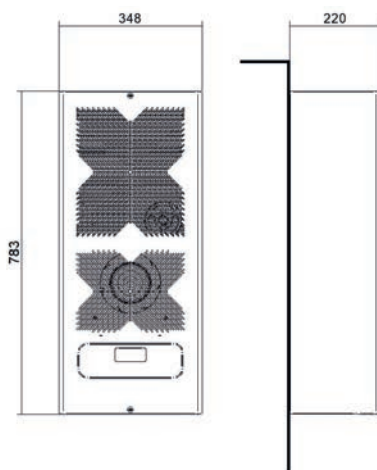
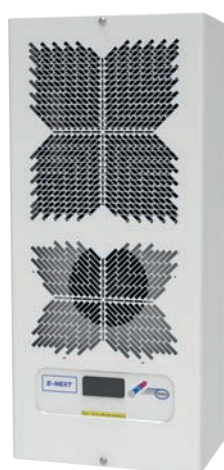

## PERFORMANCE

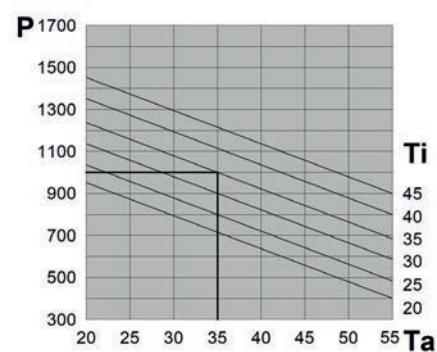

- P = Cooling capacity (W)
- Ta = Ambient Temperature (°C)
- Ti = Internal cabinet temperature (°C)

Features	UoM	NOX10B0E1C00000	NOX10K0E1C00000	NOX10B0E1U00000	NOX10C0E1U00000	NOX10K0E1U00000
Cooling capacity EN14511 - A35A35	W	1000	1000	1000	1000	1000
Cooling capacity EN14511 - A35A50	W	760	760	760	760	760
Power supply	V ~ Hz	230 - 1 - 50/60	400/460 - 2 - 50/60	230 - 1 - 50/60	115 - 1 - 60	400/460 - 2 - 50/60
Width - Height - Depth	mm	348 - 783 - 220	348 - 783 - 220	348 - 783 - 220	348 - 783 - 220	348 - 783 - 220
Max current	A	3	1.7	3	5.7	1.7
Inrush current	A	13.1	7.5	13.1	28	7.5
T Fuse	A	6	4	6	10	4
Power draw EN14511 - A35A35	W	500	500	500	570	500
Power draw EN14511 - A35A50	W	600	600	600	670	600
Electrical connection	-	4-pin plug	4-pin plug	4-pin plug	4-pin plug	4-pin plug
Cabinet air fan capacity	m <sup>3</sup> /h	540	540	540	540	540
Internal temperature range	°C	20-45	20-45	20-45	20-45	20-45
Temperature regulation	-	Electronic thermostat TX-i40 factory set to 35°C, with 3m cable and DIN rail installation kit				
External temperature range	°C	-20 - +55	-20 - +55	-20 - +55	-20 - +55	-20 - +55
Ingress protection - cabinet side	-	IP55	IP55	NEMA TYPE 4/4X	NEMA TYPE 4/4X	NEMA TYPE 4/4X
Noise level	dB (A)	65	65	65	65	65
Weight	kg	27	29	27	27	29
Conformity	-	CE UK EPA	CE UK EPA	UL CE UK EPA	UL CE UK EPA	UL CE UK EPA

\* Type 4X only in stainless steel framework version

# NOX12

## Wall-mount air conditioners for outdoor applications

COOLING CAPACITY 1250 W

### DIMENSIONS

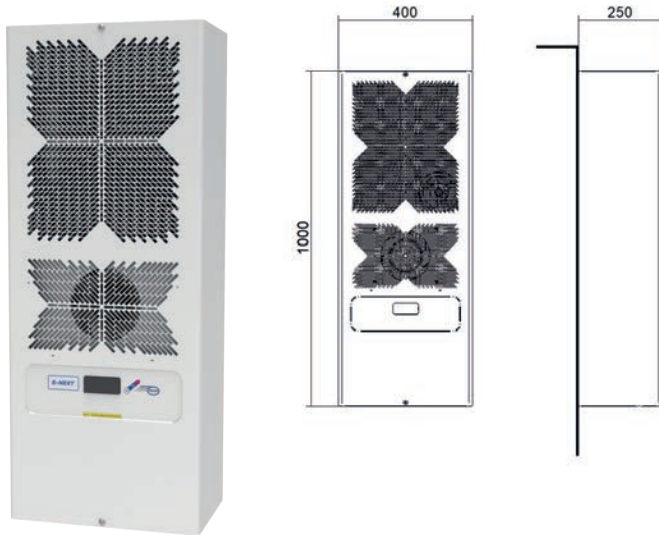

### PERFORMANCE

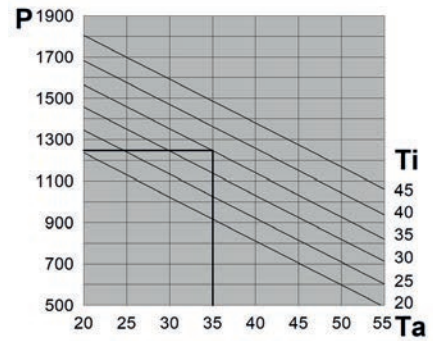

- P = Cooling capacity (W)
- Ta = Ambient Temperature (°C)
- Ti = Internal cabinet temperature (°C)

Features	UoM	NOX12B0E1C00000	NOX12K0E1C00000	NOX12B0E1U00000	NOX12C0E1U00000
Cooling capacity EN14511 - A35A35	W	1250	1250	1250	1250
Cooling capacity EN14511 - A35A50	W	930	930	930	930
Power supply	V ~ Hz	230 - 1 - 50/60	400/460 - 2 - 50/60	230 - 1 - 50/60	115 - 1 - 60
Width - Height - Depth	mm	400 - 1000 - 250	400 - 1000 - 250	400 - 1000 - 250	400 - 1000 - 250
Max current	A	3.2	1.8	3.2	6.1
Inrush current	A	17.1	9.8	17.1	28
T Fuse	A	6	4	6	10
Power draw EN14511 - A35A35	W	590	590	590	620
Power draw EN14511 -A35A50	W	680	680	680	760
Electrical connection	-	4-pin plug	4-pin plug	4-pin plug	4-pin plug
Cabinet air fan capacity	m <sup>3</sup> /h	540	540	540	540
Internal temperature range	°C	20-45	20-45	20-45	20-45
Temperature regulation	-	Electronic thermostat TX-i40 factory set to 35°C, with 3m cable and DIN rail installation kit			
External temperature range	°C	-20 - +55	-20 - +55	-20 - +55	-20 - +55
Ingress protection - cabinet side	-	IP55	IP55	NEMA TYPE 4/4X	NEMA TYPE 4/4X
Noise level	dB (A)	65	65	65	65
Weight	kg	39	41	39	39
Conformity	-	CE UK CA	CE UK CA	CE UK CA	CE UK CA

\* Type 4X only in stainless steel framework version

# NOX16

## Wall-mount air conditioners for outdoor applications

COOLING CAPACITY

1600 W

## DIMENSIONS

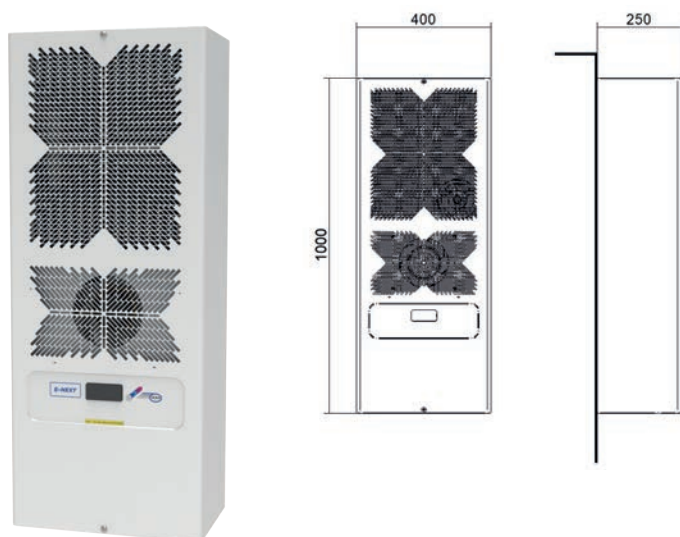

## PERFORMANCE

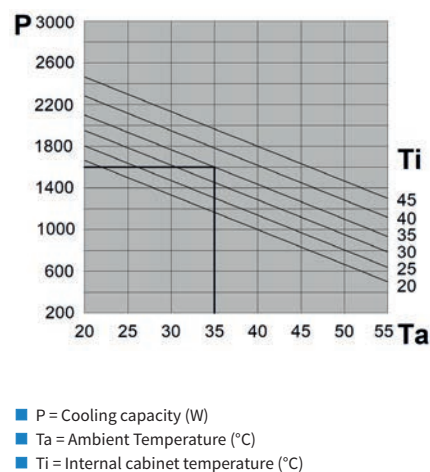

Features	UoM	NOX16B0E1C00000	NOX16K0E1C00000	NOX16B0E1U00000	NOX16C0E1U00000	NOX16K0E1U00000
Cooling capacity EN14511 - A35A35	W	1600	1600	1600	1600	1600
Cooling capacity EN14511 - A35A50	W	1100	1100	1100	1100	1100
Power supply	V ~ Hz	230 - 1 - 50/60	400/460 - 2 - 50/60	230 - 1 - 50/60	115 - 1 - 60	400/460 - 2 - 50/60
Width - Height - Depth	mm	400 - 1000 - 250	400 - 1000 - 250	400 - 1000 - 250	400 - 1000 - 250	400 - 1000 - 250
Max current	A	3.9	2.2	4.3	8.2	2.4
Inrush current	A	16.2	9.3	19.7	42	10.2
T Fuse	A	8	4	8	16	6
Power draw EN14511 - A35A35	W	720	720	720	830	720
Power draw EN14511 - A35A50	W	820	820	820	960	820
Electrical connection	-	4-pin plug	4-pin plug	4-pin plug	4-pin plug	4-pin plug
Cabinet air fan capacity	m <sup>3</sup> /h	540	540	540	540	540
Internal temperature range	°C	20-45	20-45	20-45	20-45	20-45
Temperature regulation	-	Electronic thermostat TX-i40 factory set to 35°C, with 3m cable and DIN rail installation kit				
External temperature range	°C	-20 - +55	-20 - +55	-20 - +55	-20 - +55	-20 - +55
Ingress protection - cabinet side	-	IP55	IP55	NEMA TYPE 4/4X	NEMA TYPE 4/4X	NEMA TYPE 4/4X
Noise level	dB (A)	65	65	65	65	65
Weight	kg	41	43	41	41	43
Conformity	-	CE UK CA	CE UK CA	CE UK CA	CE UK CA	CE UK CA

\* Type 4X only in stainless steel framework version

# NOX20

## Wall-mount air conditioners for outdoor applications

COOLING CAPACITY 2000 W

### DIMENSIONS

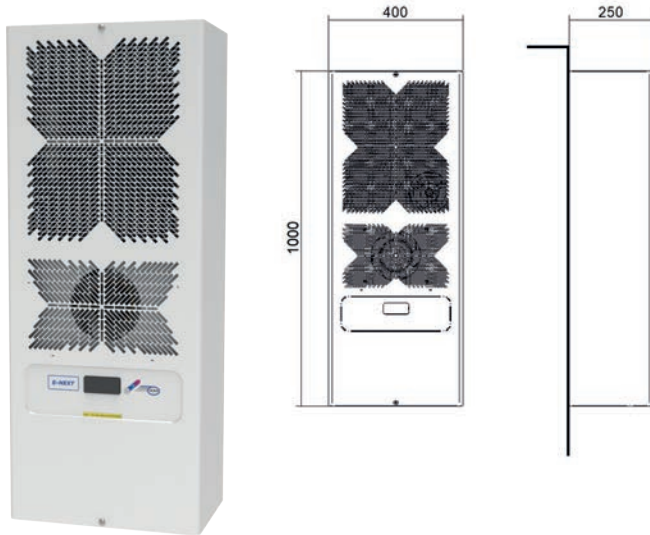

### PERFORMANCE

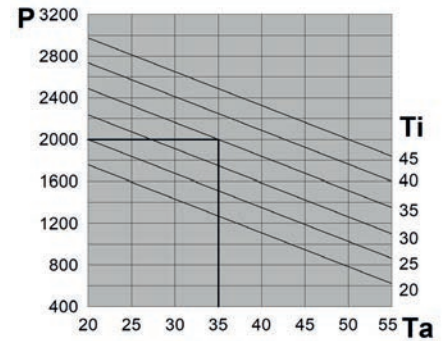

- P = Cooling capacity (W)
- Ta = Ambient Temperature (°C)
- Ti = Internal cabinet temperature (°C)

Features	UoM	NOX20B0E1C00000	NOX20H0E1C00000	NOX20B0E1U00000	NOX20C0E1U00000	NOX20H0E1U00000
Cooling capacity EN14511 - A35A35	W	2000	2000	2000	2000	2000
Cooling capacity EN14511 - A35A50	W	1500	1500	1500	1500	1500
Power supply	V ~ Hz	230 - 1 - 50/60	400/3/50 460/3/60	230 - 1 - 50/60	115 - 1 - 60	400/3/50 460/3/60
Width - Height - Depth	mm	400 - 1000 - 250	400 - 1000 - 250	400 - 1000 - 250	400 - 1000 - 250	400 - 1000 - 250
Max current	A	4.8	1.6	4.8	11.3	1.6
Inrush current	A	21.8	12	21.8	56.8	12
T Fuse	A	10	4	10	16	4
Power draw EN14511 - A35A35	W	990	870	990	1170	870
Power draw EN14511 - A35A50	W	1130	1050	1130	1360	1050
Electrical connection	-	4-pin plug	4-pin plug	4-pin plug	4-pin plug	4-pin plug
Cabinet air fan capacity	m <sup>3</sup> /h	540	540	540	540	540
Internal temperature range	°C	20-45	20-45	20-45	20-45	20-45
Temperature regulation	-	Electronic thermostat TX-i40 factory set to 35°C, with 3m cable and DIN rail installation kit				
External temperature range	°C	-20 - +55	-20 - +55	-20 - +55	-20 - +55	-20 - +55
Ingress protection - cabinet side	-	IP55	IP55	NEMA TYPE 4/4X	NEMA TYPE 4/4X	NEMA TYPE 4/4X
Noise level	dB (A)	65	65	65	65	65
Weight	kg	42	44	42	42	44
Conformity	-	CE UK CA	CE UK CA	UL CE UK CA	UL CE UK CA	UL CE UK CA

\* Type 4X only in stainless steel framework version

## Wall-mount air conditioners for outdoor applications

COOLING CAPACITY

3000 W

## DIMENSIONS

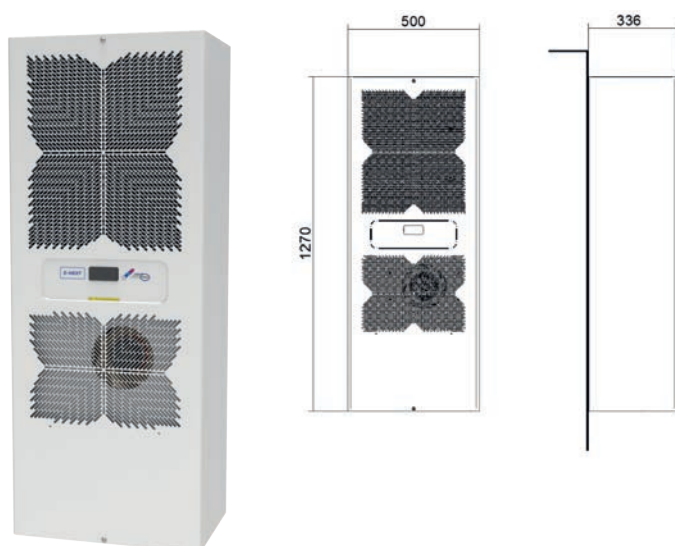

## PERFORMANCE

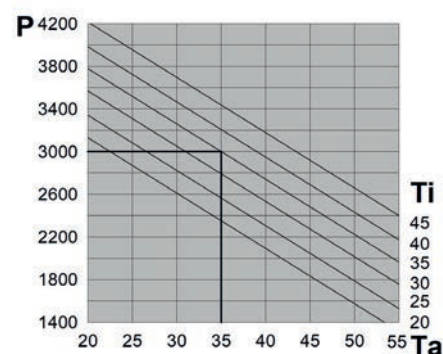

- P = Cooling capacity (W)
- Ta = Ambient Temperature (°C)
- Ti = Internal cabinet temperature (°C)

Features	UoM	NOX30B0E1C00000	NOX30H0E1C00000	NOX30B0E1U00000	NOX30H0E1U00000
Cooling capacity EN14511 - A35A35	W	3000	3000	3000	3000
Cooling capacity EN14511 - A35A50	W	2210	2210	2210	2210
Power supply	V ~ Hz	230 - 1 - 50/60	400/3/50 - 460/3/60	230 - 1 - 50/60	400/3/50 - 460/3/60
Width - Height - Depth	mm	500 - 1270 - 336	500 - 1270 - 336	500 - 1270 - 336	500 - 1270 - 336
Max current	A	5.2	2.4	5.2	2.4
Inrush current	A	35	20	35	20
T Fuse	A	10	6	10	6
Power draw EN14511 - A35A35	W	1190	1140	1190	1140
Power draw EN14511 -A35A50	W	1380	1350	1380	1350
Electrical connection	-	4-pin plug	4-pin plug	4-pin plug	4-pin plug
Cabinet air fan capacity	m <sup>3</sup> /h	1500	1500	1500	1500
Internal temperature range	°C	20-45	20-45	20-45	20-45
Temperature regulation	-	Electronic thermostat TX-i40 factory set to 35°C, with 3m cable and DIN rail installation kit			
External temperature range	°C	-20 - +55	-20 - +55	-20 - +55	-20 - +55
Ingress protection - cabinet side	-	IP55	IP55	NEMA TYPE 4/4X	NEMA TYPE 4/4X
Noise level	dB (A)	70	70	70	70
Weight	kg	66	70	66	70
Conformity	-	CE UK ECA	CE UK ECA	UL CE UK ECA	UL CE UK ECA

\* Type 4X only in stainless steel framework version

# NOX40

## Wall-mount air conditioners for outdoor applications

COOLING CAPACITY

3850 W

### DIMENSIONS

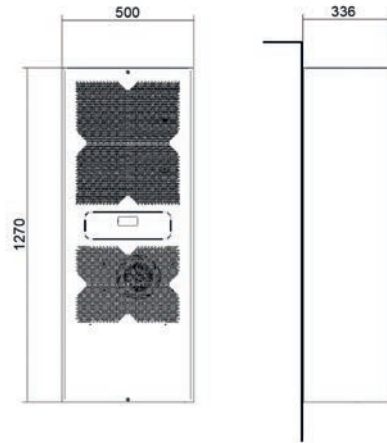

### PERFORMANCE

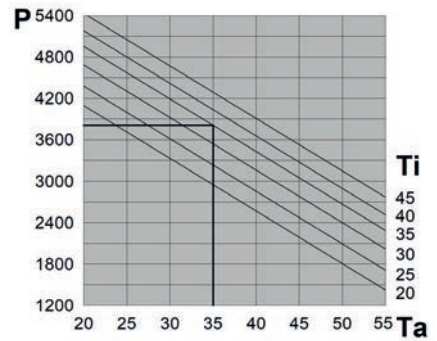

- P = Cooling capacity (W)
- Ta = Ambient Temperature (°C)
- Ti = Internal cabinet temperature (°C)

Features	UoM	NOX40B0E1C00000	NOX40H0E1C00000	NOX40B0E1U00000	NOX40H0E1U00000
Cooling capacity EN14511 - A35A35	W	3850	3850	3850	3850
Cooling capacity EN14511 - A35A50	W	2650	2650	2650	2650
Power supply	V ~ Hz	230 - 1 - 50/60	400/3/50 - 460/3/60	230 - 1 - 50/60	400/3/50 - 460/3/60
Width - Height - Depth	mm	500 - 1270 - 336	500 - 1270 - 336	500 - 1270 - 336	500 - 1270 - 336
Max current	A	7.8	3.1	7.8	3.6
Inrush current	A	37	16	37	18
T Fuse	A	16	6	16	8
Power draw EN14511 - A35A35	W	1670	1580	1670	1780
Power draw EN14511 -A35A50	W	1980	1920	1980	2050
Electrical connection	-	4-pin plug	4-pin plug	4-pin plug	4-pin plug
Cabinet air fan capacity	m <sup>3</sup> /h	1500	1500	1500	1500
Internal temperature range	°C	20-45	20-45	20-45	20-45
Temperature regulation	-	Electronic thermostat TX-i40 factory set to 35°C, with 3m cable and DIN rail installation kit			
External temperature range	°C	-20 - +55	-20 - +55	-20 - +55	-20 - +55
Ingress protection - cabinet side	-	IP55	IP55	NEMA TYPE 4/4X	NEMA TYPE 4/4X
Noise level	dB (A)	70	70	70	70
Weight	kg	70	74	70	74
Conformity	-	CE UK ECA	CE UK ECA	UL CE UK ECA	UL CE UK ECA

\* Type 4X only in stainless steel framework version

# NOX60

## Wall-mount air conditioners for outdoor applications

COOLING CAPACITY

5400 W

## DIMENSIONS

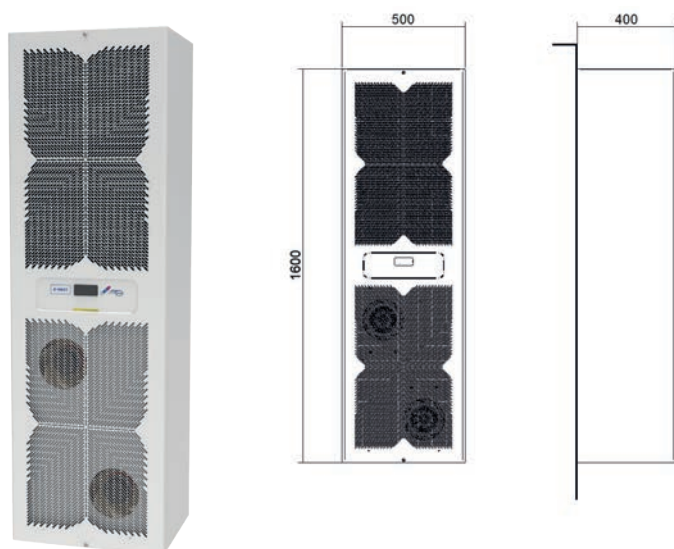

## PERFORMANCE

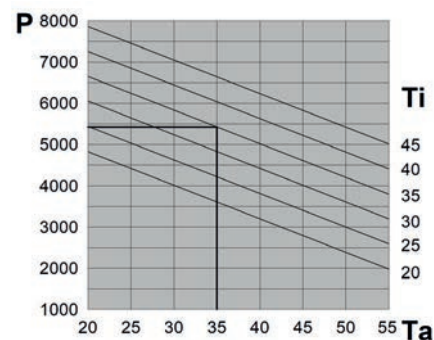

- P = Cooling capacity (W)
- Ta = Ambient Temperature (°C)
- Ti = Internal cabinet temperature (°C)

Features	UoM	NOX60H0E1C00000	NOX60H0E1U00000
Cooling capacity EN14511 - A35A35	W	5400	5400
Cooling capacity EN14511 - A35A50	W	4200	4200
Power supply	V ~ Hz	400/3/50 - 460/3/60	400/3/50 - 460/3/60
Width - Height - Depth	mm	500 - 1600 - 400	500 - 1600 - 400
Max current	A	3.7	3.7
Inrush current	A	32	32
T Fuse	A	8	8
Power draw EN14511 - A35A35	W	1950	1950
Power draw EN14511 -A35A50	W	2470	2470
Electrical connection	-	4-pin plug	4-pin plug
Cabinet air fan capacity	m <sup>3</sup> /h	1500	1500
Internal temperature range	°C	20-45	20-45
Temperature regulation	-	Electronic thermostat TX-i40 factory set to 35°C, with 3m cable and DIN rail installation kit	
External temperature range	°C	-20 - +55	-20 - +55
Ingress protection - cabinet side	-	IP55	NEMA TYPE 4/4X
Noise level	dB (A)	72	72
Weight	kg	104	104
Conformity	-	CE UK EAC	CE UK EAC

\* Type 4X only in stainless steel framework version





# EMO

## Wall-mount air conditioners for outdoor application

### REGULATION AND SAFETY DEVICES

EMO air conditioning systems are equipped with electromechanical thermostatic regulation which guarantees maximum reliability even in extreme conditions. The refrigeration circuit is protected by low- and high-pressure safety pressure switches with automatic rearming. A fixed calibration pressure switch with ON/OFF contact manages the condensing fan.

### QUICK INSTALLATION

Installation is made quick by the simplicity of the drilling to be performed on the cabinet panel.

### REDUCED MAINTENANCE

All units are designed to prevent clogging by solid contaminants present in the ambient air. The condensing coils are protected by a cataphoresis treatment which prevents fouling and corrosion.

### OPERATING TEMPERATURE

The possible operating temperatures range from -20 to +55°C. The temperature inside the cabinet can be adjusted from +20 to +46°C (the air conditioner is factory set to +35°C).

### OPTIONAL ACCESSORIES

EMO air conditioners offer various optional accessories:

- stainless-steel framework
- evaporating fan with separate 48VDC power supply
- tamper-resistant screw kit for front casing closure
- high temperature alarm warning
- common high/low pressure alarm



# EMO60

## Wall-mount air conditioners for outdoor application

COOLING CAPACITY 5800 - 6050 W



Features	UoM	EMO60MMEB	EMO60NMEB
Cooling capacity EN14511 - A35A35	W	5800	6050
Cooling capacity EN14511 - A35A50	W	4350	4530
Power supply	V ~ Hz	400 3~ 50	460 3~ 60
Width - Height - Depth	mm	600 - 2000 - 387	600 - 2000 - 387
Max current	A	5.9	6.8
Inrush current	A	21.7	23.5
T Fuse	A	8	8
Power draw EN14511 - A35A35	W	2340	2920
Power draw EN14511 - A35A50	W	3880	4520
Electrical connection	-	Cable L = 3 m	Cable L = 3 m
R407C Refrigerant	kg	1.8	1.8
Cabinet air fan capacity	m <sup>3</sup> /h	1450	1450
Internal temperature range	°C	+20 - +45	+20 - +45
Temperature regulation	-	Electromechanical thermostat, factory set to 35°C	
External temperature range	°C	-20 - +50	-20 - +50
EN60529 ingress protection - cabinet side	-	IP54	IP54
Noise level	dB (A)	72	72
Weight	kg	150	150
Conformity	-	CE	CE

### PERFORMANCE (EMO60MMEB)

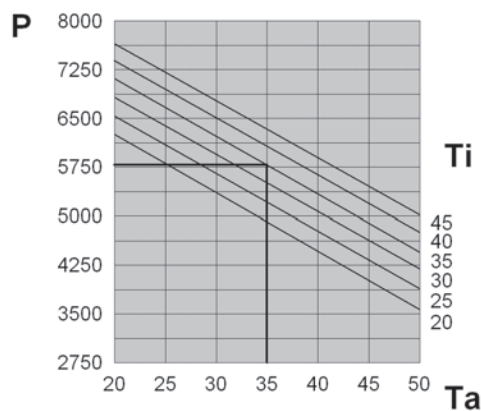

- P = Cooling capacity (W)
- Ta = Ambient Temperature (°C)
- Ti = Internal cabinet temperature (°C)

### DIMENSIONS

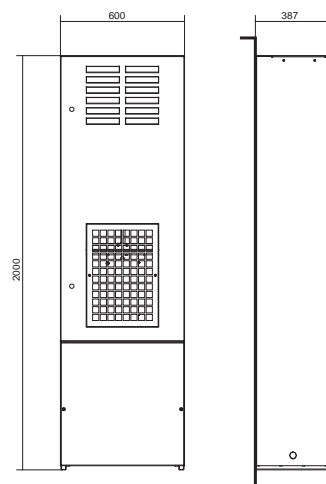

# EMO80

## Wall-mount air conditioners for outdoor application

COOLING CAPACITY

7600 - 7950 W



Features	UoM	EMO80MMEB	EMO80NMEB
Cooling capacity EN14511 - A35A35	W	7600	7950
Cooling capacity EN14511 - A35A50	W	5700	5930
Power supply	V ~ Hz	400 3~ 50	460 3~ 60
Width - Height - Depth	mm	800 - 2000 - 387	800 - 2000 - 387
Max current	A	8.1	9.3
Inrush current	A	30.7	32.5
T Fuse	A	16	16
Power draw EN14511 - A35A35	W	3300	4035
Power draw EN14511 - A35A50	W	4910	5845
Electrical connection	-	Cable L = 3 m	Cable L = 3 m
R134a Refrigerant	kg	2.8	2.8
Cabinet air fan capacity	m <sup>3</sup> /h	2900	2900
Internal temperature range	°C	+20 - +45	+20 - +45
Temperature regulation	-	Electromechanical thermostat, factory set to 35°C	
External temperature range	°C	-20 - +50	-20 - +50
EN60529 ingress protection - cabinet side	-	IP54	IP54
Noise level	dB (A)	75	75
Weight	kg	160	160
Conformity	-	CE	CE

### PERFORMANCE (EMO80MMEB)

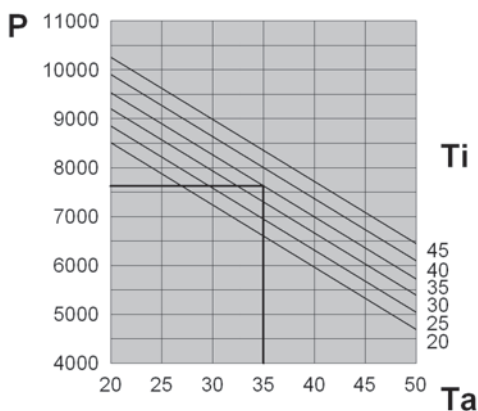

- P = Cooling capacity (W)
- Ta = Ambient Temperature (°C)
- Ti = Internal cabinet temperature (°C)

### DIMENSIONS

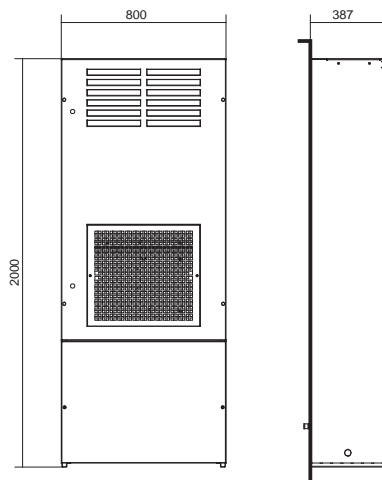

# EMOA0

## Wall-mount air conditioners for outdoor application

COOLING CAPACITY 9400 - 9850 W



Features	UoM	EMOA0MMEB	EMOA0NMEB
Cooling capacity EN14511 - A35A35	W	9400	9850
Cooling capacity EN14511 - A35A50	W	7000	7350
Power supply	V ~ Hz	400 3~ 50	460 3~ 60
Width - Height - Depth	mm	800 - 2000 - 387	800 - 2000 - 387
Max current	A	9.1	10.3
Inrush current	A	30.7	32.5
T Fuse	A	18	18
Power draw EN14511 - A35A35	W	3650	4380
Power draw EN14511 - A35A50	W	5400	6340
Electrical connection	-	Cable L = 3 m	Cable L = 3 m
R134a Refrigerant	kg	2.3	2.3
Cabinet air fan capacity	m <sup>3</sup> /h	2900	2900
Internal temperature range	°C	+20 - +45	+20 - +45
Temperature regulation	-	Electromechanical thermostat, factory set to 35°C	
External temperature range	°C	-20 - +50	-20 - +50
EN60529 ingress protection - cabinet side	-	IP54	IP54
Noise level	dB (A)	77	77
Weight	kg	180	180
Conformity	-	CE	CE

\* IP54 rated exterior electrical connections

### PERFORMANCE (EMOA0MMEB)

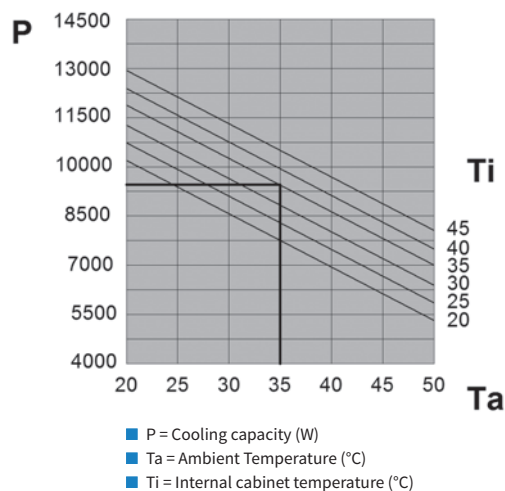

### DIMENSIONS

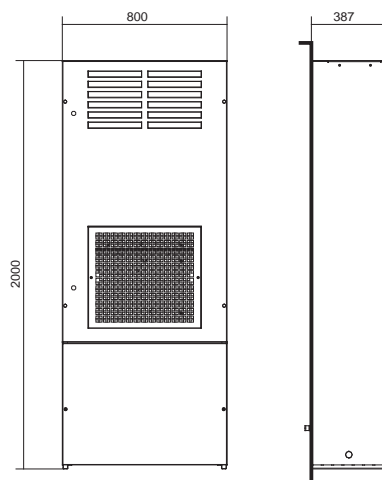

## FILTERS



Models	Item code	Quantity per pack
EMO60	C15000175	5
EMO80-A0	C15000188	5

### AAEFP/AADFP

#### PU foam filter for air conditioners

Texa industries **air conditioners** are designed not to require maintenance and are supplied without filters for the external air intake. However, when the ambient air is particularly contaminated by oily aerosols or particles, users can choose to insert a filter in the space provided at the rear of the intake grille. These filters are made from an alveolar polyurethane foam with highly stable mechanical and chemical properties.



Models	Item code	Quantity per pack
EMO60	C15000176	1
EMO80-A0	C15000189	1

### AAEFM/AADFM

#### Regenerable air filters for air conditioners

In extreme environmental conditions, the air conditioners can be fitted with metal air filters. They provide less efficient filtration than the PU foam filters, but have the advantage that they are regenerable. They can be cleaned with degreaser and reused as many times as the user wishes.

They are made from an aluminium mesh.

# BLU-BIT

## Air-water heat exchangers for door/wall and roof installation

High cooling power capacities with reduced unit sizes, completely free from scheduled maintenance. These are the main features of the BLU-BIT range, the best choice of air conditioner when working in extreme temperature environments with dust and oil contamination.

### WIDE RANGE OF POWER OUTPUTS

The range of cooling power outputs ranges from 1000 to 25000 W for the vertical range, while the roof range is represented by a 2500 W model.

### NO SCHEDULED MAINTENANCE

The special layout of these machines means they do not require regular/scheduled maintenance (replacement of filters or cleaning of the heat exchanger) to guarantee full operation.

### OPTIMISED PROTECTION OF THE CABINET

BLU/BIT heat exchangers, thanks to their innovative design combined with the correct application of the self-adhesive sealing gasket, guarantees IP55 ingress protection (EN 60529), meaning they are ideal for particularly contaminated outdoor environments.

### ACCESSORIES

In order to optimise the heat exchange on the basis of the temperature required inside the enclosure and allow correct condensate management, thermostats can be incorporated to control an ON/OFF solenoid valve which will allow or inhibit the water flow.





# BIT25

## Air-water heat exchangers for roof installation

COOLING CAPACITY 2500 W



### PERFORMANCE

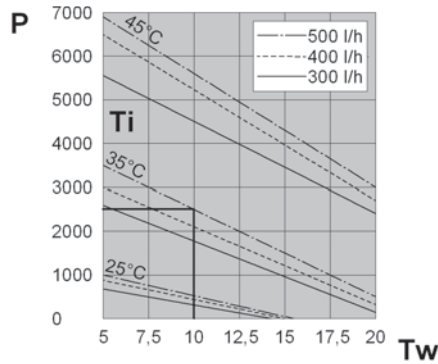

- P = Cooling capacity (W)
- Tw = Water inlet temperature (°C)
- Ti = Internal cabinet temperature (°C)

### DIMENSIONS

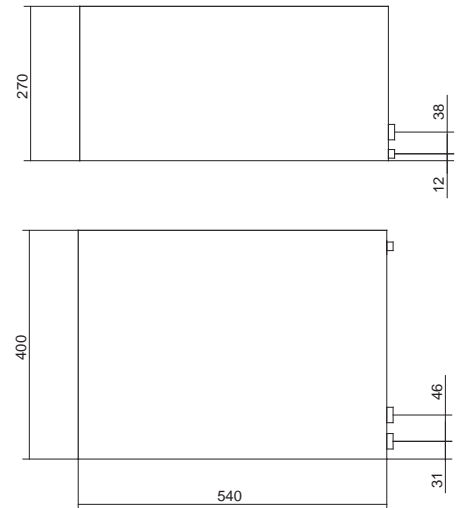

Features	UoM	BIT25BX0B	BIT25CX0B
Cooling capacity - W10A35	W	2500	2500
Water flow rate	l/h	500	500
Power supply	V ~ Hz	230 1~ 50-60	115 1~ 50-60
Width - Height - Depth	mm	400 - 270 - 540	400 - 270 - 540
Max current	A	0.30	0.62
T Fuse	A	2	2
Power draw - W10A35	W	65	67
Electrical connection	-	Cable L = 3 m	Cable L = 3 m
Max liquid circuit pressure	bar	10	10
Water connection	-	1/2"G	1/2"G
Air flow rate	m <sup>3</sup> /h	750	750
Internal temperature range	°C	20-60	20-60
External temperature range	°C	1-70	1-70
IP rating EN60529	-	IP55	IP55
Noise level	dB (A)	58	58
Weight	kg	19	19
Conformity	-	CE	CE
Pressure drops	Bar	0.3	0.3

# BLU10

## Air-water heat exchangers for door or wall installation

COOLING CAPACITY 1000 W



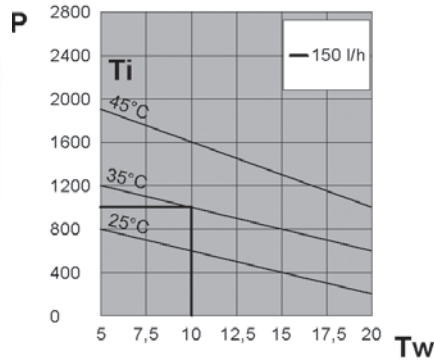

### PERFORMANCE

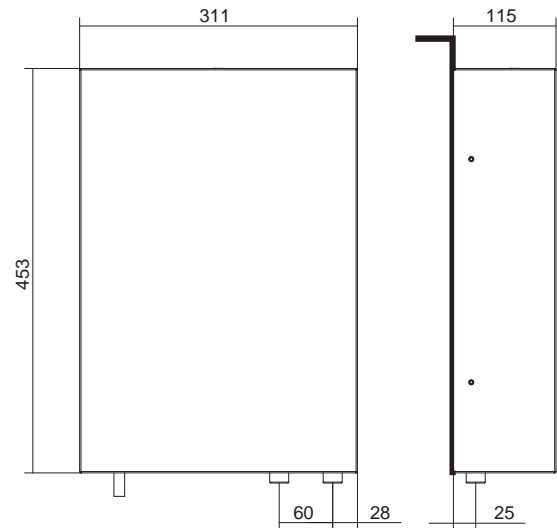

- P = Cooling capacity (W)
- Tw = Water inlet temperature (°C)
- Ti = Internal cabinet temperature (°C)

### DIMENSIONS



Features	UoM	BLU10BX0B	BLU10BXUB	BLU10CX0B
Cooling capacity - W10A35	W	1000	1000	1000
Water flow rate	l/h	150	150	150
Power supply	V ~ Hz	230 1~ 50-60	230 1~ 50-60	115 1~ 50-60
Width - Height - Depth	mm	311 - 453 - 115	311 - 453 - 115	311 - 453 - 115
Max current	A	0.17	0.20	0.38
T Fuse	A	2	2	2
Power draw - W10A35	W	29	34	25
Electrical connection		Cable L = 3 m	Cable L = 3 m	Cable L = 3 m
Max liquid circuit pressure	bar	10	10	10
Water connection	-	3/8"G	3/8"G	3/8"G
Air flow rate	m <sup>3</sup> /h	330	330	330
Internal temperature range	°C	20-60	20-60	20-60
External temperature range	°C	1-70	1-60	1-70
IP rating EN60529	-	IP55	IP55	IP55
Noise level	dB (A)	55	55	55
Weight	kg	12	12	12
Conformity	-	CE	CE 	CE
Pressure drops	Bar	0.1	0.1	0.1

## Air-water heat exchangers for door or wall installation

COOLING CAPACITY 1750 W



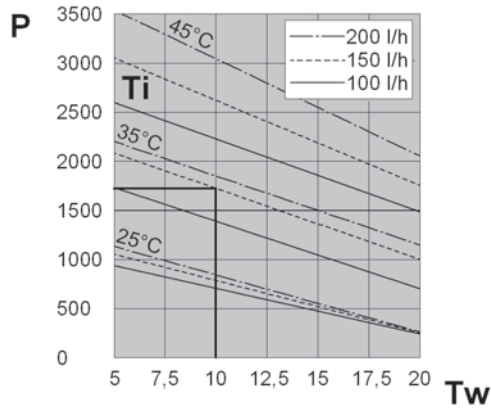

### PERFORMANCE

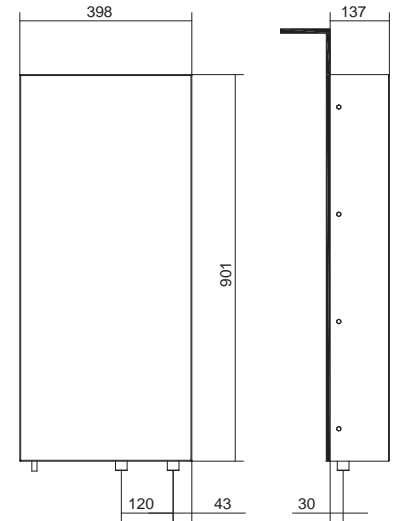

- P = Cooling capacity (W)
- Tw = Water inlet temperature (°C)
- Ti = Internal cabinet temperature (°C)

### DIMENSIONS



Features	UoM	BLU18BX0B	BLU18BXUB	BLU18CX0B
Cooling capacity - W10A35	W	1750	1750	1750
Water flow rate	l/h	150	150	150
Power supply	V ~ Hz	230 1~ 50-60	230 1~ 50-60	115 1~ 50-60
Width - Height - Depth	mm	398 - 901 - 137	398 - 901 - 137	398 - 901 - 137
Max current	A	0.36	0.30	0.76
T Fuse	A	2	2	2
Power draw - W10A35	W	75	60	77
Electrical connection	-	Cable L = 3 m	Cable L = 3 m	Cable L = 3 m
Max liquid circuit pressure	bar	10	10	10
Water connection	-	1/2" G	1/2" G	1/2" G
Air flow rate	m <sup>3</sup> /h	570	570	570
Internal temperature range	°C	20-60	20-60	20-60
External temperature range	°C	1-70	1-60	1-70
IP rating EN60529	-	IP55	IP55	IP55
Noise level	dB (A)	58	58	58
Weight	kg	18		18
Conformity	-	CE	CE  	CE
Pressure drops	Bar	0.1	0.1	0.1

# BLU25

## Air-water heat exchangers for door or wall installation

COOLING CAPACITY 2500 W



### PERFORMANCE

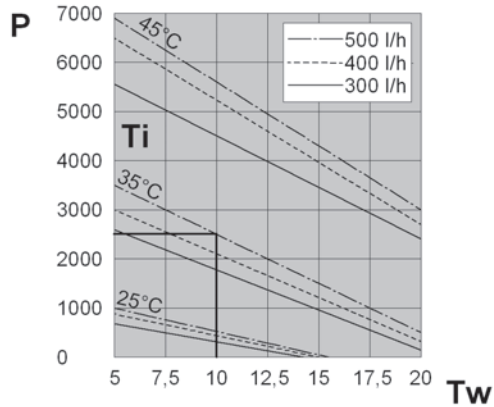

- P = Cooling capacity (W)
- Tw = Water inlet temperature (°C)
- Ti = Internal cabinet temperature (°C)

### DIMENSIONS

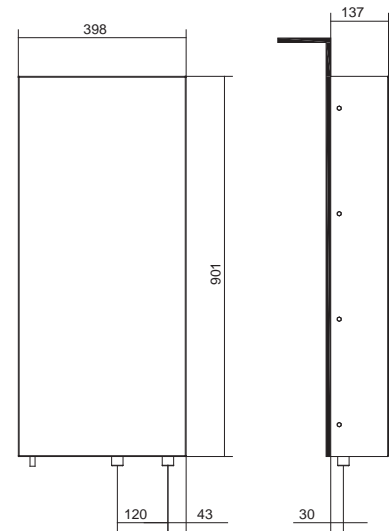

Features	UoM	BLU25BX0B	BLU25BXUB	BLU25CX0B
Cooling capacity - W10A35	W	2500	2500	2500
Water flow rate	l/h	500	500	500
Power supply	V ~ Hz	230 1~ 50-60	230 1~ 50-60	115 1~ 50-60
Width - Height - Depth	mm	398 - 901 - 137	398 - 901 - 137	398 - 901 - 137
Max current	A	0.33	0.60	0.74
T Fuse	A	2	2	2
Power draw - W10A35	W	80	100	82
Electrical connection		Cable L = 3 m	Cable L = 3 m	Cable L = 3 m
Max liquid circuit pressure	bar	10	10	10
Water connection	-	1/2"G	1/2"G	1/2"G
Air flow rate	m <sup>3</sup> /h	860	860	860
Internal temperature range	°C	20-60	20-60	20-60
External temperature range	°C	1-70	1-60	1-70
IP rating EN60529	-	IP55	IP55	IP55
Noise level	dB (A)	58	58	58
Weight	kg	19	19	19
Conformity	-	CE	CE & UL US	CE
Pressure drops	Bar	0.3	0.3	0.3

# BLU35

## Air-water heat exchangers for door or wall installation

COOLING CAPACITY 3500 W



### PERFORMANCE

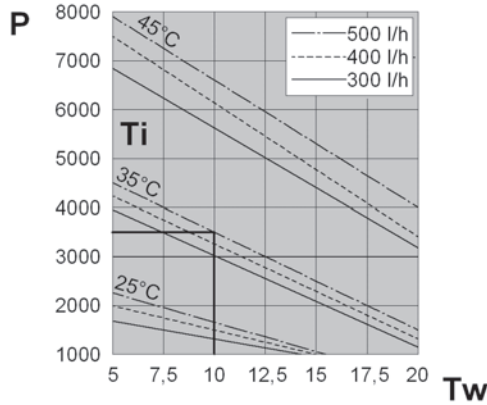

- P = Cooling capacity (W)
- Tw = Water inlet temperature (°C)
- Ti = Internal cabinet temperature (°C)

### DIMENSIONS

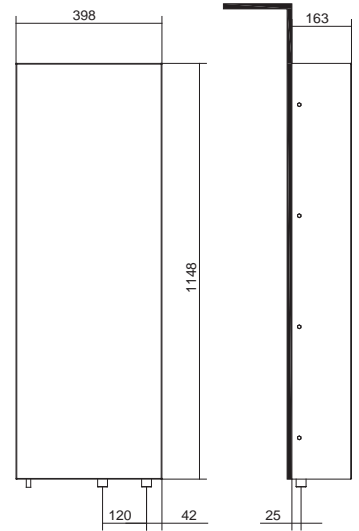

Features	UoM	BLU35BX0B	BLU35BXUB	BLU35CX0B
Cooling capacity - W10A35	W	3500	3500	3500
Water flow rate	l/h	500	500	500
Power supply	V ~ Hz	230 1~ 50-60	230 1~ 50-60	115 1~ 50-60
Width - Height - Depth	mm	398- 1148 - 163	398 - 1148 - 163	398 - 1148 - 163
Max current	A	0.55	0.80	1.12
T Fuse	A	2	2	2
Power draw - W10A35	W	130	140	135
Electrical connection	-	Cable L = 3 m	Cable L = 3 m	Cable L = 3 m
Max liquid circuit pressure	bar	10	10	10
Water connection	-	1/2"G	1/2"G	1/2"G
Air flow rate	m <sup>3</sup> /h	1050	1050	1050
Internal temperature range	°C	20-60	20-60	20-60
External temperature range	°C	1-70	1-60	1-70
IP rating EN60529	-	IP55	IP55	IP55
Noise level	dB (A)	64	64	64
Weight	kg	29	29	29
Conformity	-	CE	CE  US	CE
Pressure drops	Bar	0.2	0.2	0.2

# BLU45

## Air-water heat exchangers for door or wall installation

COOLING CAPACITY 4500 W



### PERFORMANCE

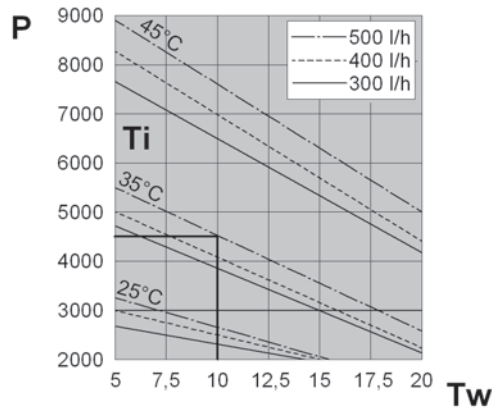

- P = Cooling capacity (W)
- Tw = Water inlet temperature (°C)
- Ti = Internal cabinet temperature (°C)

### DIMENSIONS

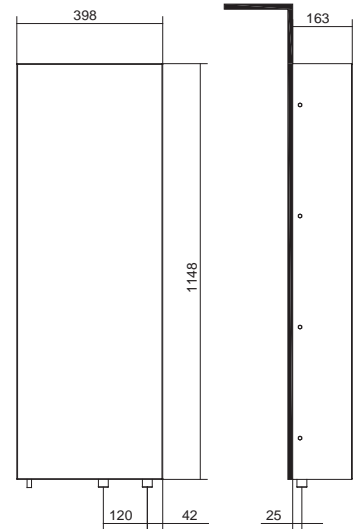

Features	UoM	BLU45BX0B	BLU45BXUB	BLU45CX0B
Cooling capacity - W10A35	W	4500	4500	4500
Water flow rate	l/h	500	500	500
Power supply	V ~ Hz	230 1~ 50-60	230 1~ 50-60	115 1~ 50-60
Width - Height - Depth	mm	398 - 148 - 163	398 - 1148 - 163	398 - 1148 - 163
Max current	A	0.71	1.20	1.50
T Fuse	A	2	4	4
Power draw - W10A35	W	160	220	170
Electrical connection		Cable L = 3 m	Cable L = 3 m	Cable L = 3 m
Max liquid circuit pressure	bar	10	10	10
Water connection	-	1/2"G	1/2"G	1/2"G
Air flow rate	m <sup>3</sup> /h	1450	1450	1450
Internal temperature range	°C	20-60	20-60	20-60
External temperature range	°C	1-70	1-60	1-70
IP rating EN60529	-	IP55	IP55	IP55
Noise level	dB (A)	69	69	69
Weight	kg	30	30	30
Conformity	-	CE	CE c  US	CE
Pressure drops	Bar	0.2	0.2	0.2

# BLU60

## Air-water heat exchangers for door or wall installation

COOLING CAPACITY **6000 W**



### PERFORMANCE

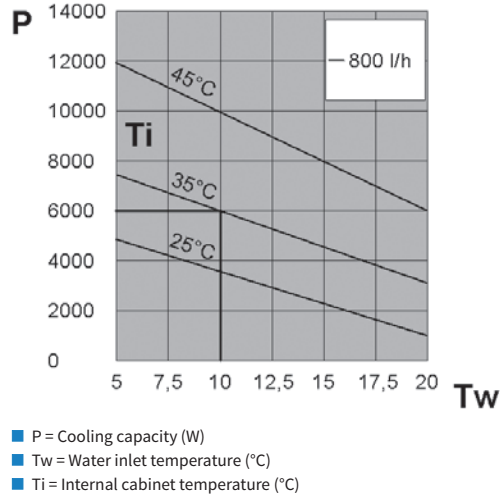

### DIMENSIONS

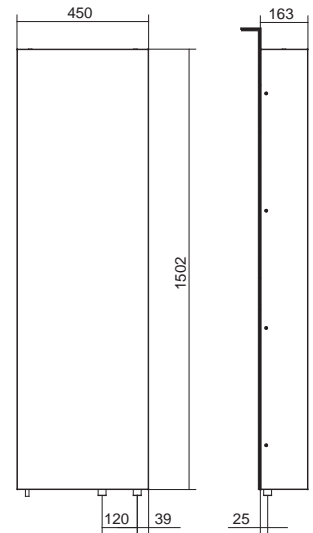

Features	UoM	BLU60BX0B	BLU60BXUB	BLU60CX0B	BLU60GX0B
Cooling capacity - W10A35	W	6000	6000	6000	6000
Water flow rate	l/h	800	800	800	800
Power supply	V - Hz	230 1~ 50-60	230 1~ 50-60	115 1~ 50-60	400/440 2~ 50-60
Width - Height - Depth	mm	450 - 1502 - 163	450 - 1502 - 163	450 - 1502 - 163	450 - 1502 - 163
Max current	A	0.71	1.20	1.50	0.40
T Fuse	A	2	4	4	1
Power draw - W10A35	W	160	220	170	170
Electrical connection		Cable L = 3 m	Cable L = 3 m	Cable L = 3 m	Cable L = 3 m
Max liquid circuit pressure	bar	10	10	10	10
Water connection	m <sup>3</sup> /h	1/2"G	1/2"G	1/2"G	1/2"G
Air flow rate	-	1450	1450	1450	1450
Internal temperature range	°C	20-60	20-60	20-60	20-60
External temperature range	°C	1-70	1-60	1-70	1-70
EN60529 ingress protection - cabinet side	-	IP55	IP55	IP55	IP55
Noise level	dB (A)	69	69	69	69
Weight	kg	40	40	40	42
Conformity	-	CE	CE 	CE	CE
Pressure drops	Bar	0.5	0.5	0.5	0.5



# BLUA0

## Air-water heat exchangers for door or wall installation

COOLING CAPACITY 10000 W



### PERFORMANCE

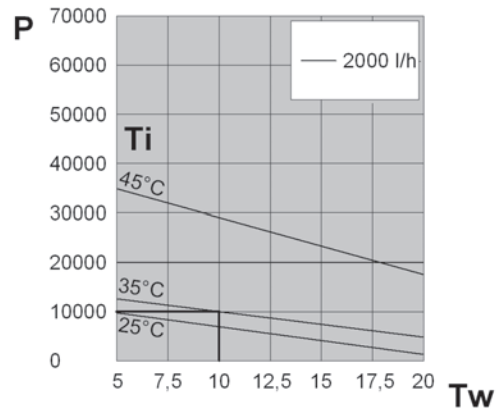

- P = Cooling capacity (W)
- Tw = Water inlet temperature (°C)
- Ti = Internal cabinet temperature (°C)

### DIMENSIONS

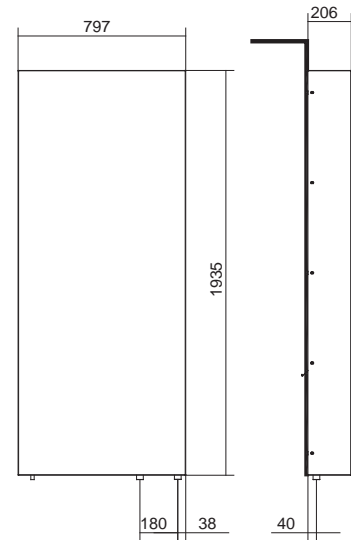

Features	UoM	BLUA0BX0B	BLUA0GX0B
Cooling capacity - W10A35	W	10000	10000
Water flow rate	l/h	2000	2000
Power supply	V ~ Hz	230 1~ 50-60	400/440 2~ 50-60
Width - Height - Depth	mm	797 - 1935 - 206	797 - 1935 - 206
Max current	A	1.90	1.10
T Fuse	A	4	2
Power draw - W10A35	W	420	440
Electrical connection	-	Cable L = 3 m	Cable L = 3 m
Max liquid circuit pressure	bar	10	10
Water connection	-	3/4"G	3/4"G
Air flow rate	m <sup>3</sup> /h	2900	2900
Internal temperature range	°C	20-60	20-60
External temperature range	°C	1-70	1-70
IP rating EN60529	-	IP55	IP55
Noise level	dB (A)	70	70
Weight	kg	90	90
Conformity	-	CE	CE
Pressure drops	Bar	1.5	1.5

# BLUA5

## Air-water heat exchangers for door or wall installation

COOLING CAPACITY **15000 W**



### PERFORMANCE

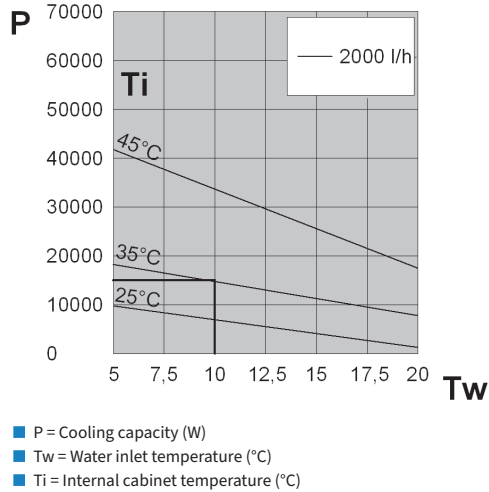

### DIMENSIONS

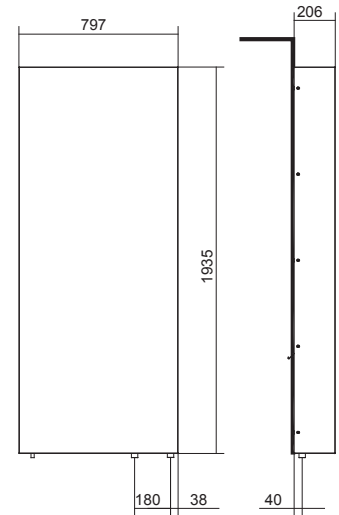

Features	UoM	BLUA5BX0B	BLUA5GX0B
Cooling capacity - W10A35	W	15000	15000
Water capacity	l/h	2000	2000
Power supply	V ~ Hz	230 1~ 50-60	400/440 2~ 50-60
Width - Height - Depth	mm	797 - 1935 - 206	797 - 1935 - 206
Max current	A	1.40	0.90
T Fuse	A	4	2
Power draw - W10A35	W	320	340
Operating cycle	-	100%	100%
Electrical connection	-	Cable L = 3 m	Cable L = 3 m
Type of Refrigerant	-	Water	Water
Max liquid circuit pressure	bar	10	10
Water connection	-	3/4" G	3/4" G
Air flow rate	m <sup>3</sup> /h	2900	2900
Internal temperature range	°C	20-60	20-60
External temperature range	°C	1-70	1-70
IP rating EN60529	-	IP55	IP55
Noise level	dB (A)	72	70
Weight	kg	92	92
Conformity	-	CE	CE
Pressure drops	Bar	1.8	1.8

# BLUB5

## Air-water heat exchangers for door or wall installation

COOLING CAPACITY 25000 W

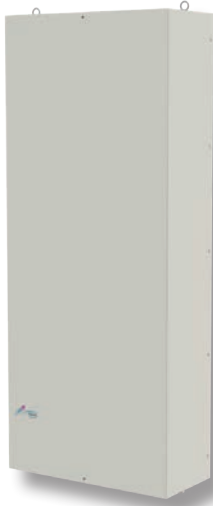

### PERFORMANCE

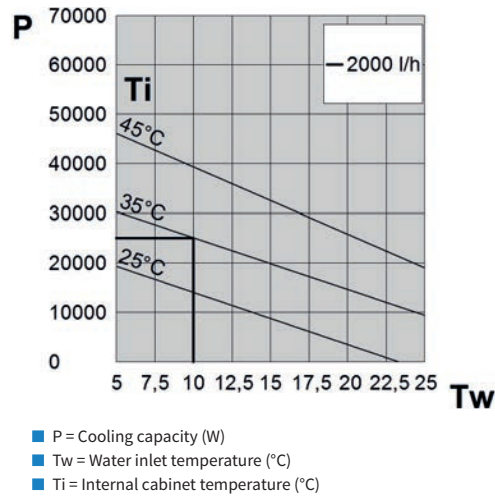

### DIMENSIONS

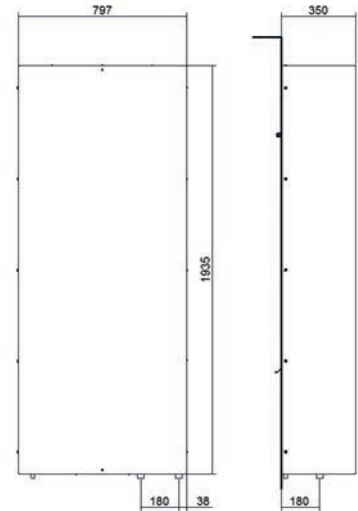

Features	UoM	BLUB5BX0B	BLUB5KX0B
Cooling capacity - W10A35	W	25000	25000
Water flow rate	l/h	2000	2000
Power supply	V ~ Hz	230 1~ 50-60	400/460 2~ 50-60
Width - Height - Depth	mm	797 - 1935 - 350	797- 1935 - 350
Max current	A	2.20	1.30
T Fuse	A	4	2
Power draw - W10A35	W	500	530
Operating cycle	-	100%	100%
Electrical connection	-	Cable L = 3 m	Cable L = 3 m
Type of Refrigerant	-	Water	Water
Max liquid circuit pressure	bar	10	10
Water connection	-	3/4"G	3/4"G
Air flow rate	m <sup>3</sup> /h	5200	5200
Internal temperature range	°C	20-60	20-60
External temperature range	°C	1-70	1-70
IP rating EN60529	-	IP55	IP55
Noise level	dB (A)	75	75
Weight	kg	120	120
Conformity	-	CE	CE
Pressure drops	Bar	2.0	2.0

# MIX

## Air-air heat exchangers

High heat exchange efficiency and compact size. The MIX range is the most cost-effective solution for cooling cabinets in favourable ambient conditions.

### WIDE RANGE OF SPECIFIC POWER OUTPUTS

The specific thermal power outputs range from 22 to 80 W/K.

### FLEXIBILITY AND SPEED OF INSTALLATION

All heat exchangers in the MIX range can be installed both inside and outside the cabinet as both a rear exit and a side exit for electrical connections is provided for.

### FAST, REDUCED MAINTENANCE

MIX heat exchangers are equipped with heat exchange coils which prevent clogging by solid contaminants present in the air and which maintain high thermal exchange efficiency even in demanding environmental conditions, minimising maintenance requirements. The remaining maintenance required has been designed to allow easy removal both of the fans and the heat exchanger coil to ensure quick and safe operations.

### MAXIMUM HEAT REMOVAL

Air intake from the upper part of the cabinet, countercurrent flows and high-efficiency heat exchanger surfaces determine the most rational implementation for these products which result in the removal of the maximum amount of heat.



# MIX22

## Air-air heat exchangers

SPECIFIC COOLING POWER 22 W/K



### PERFORMANCE

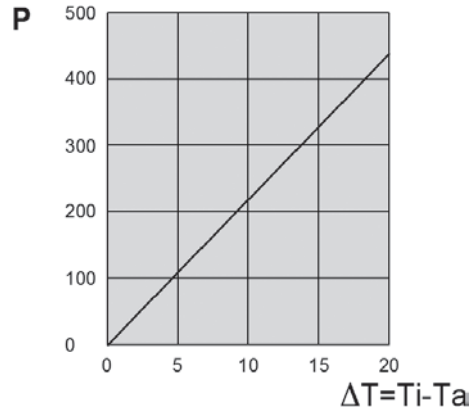

- P = Heating capacity (W)
- $\Delta T$  = Temperature differential (Tint-Tamb) (K)

### DIMENSIONS

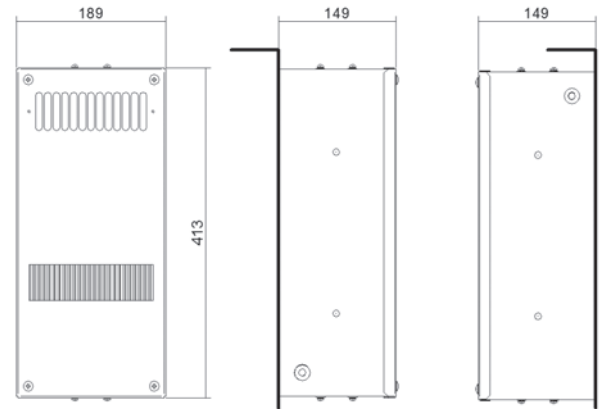

Features	UoM	MIX22BX0B	MIX22CX0B
Specific cooling power	W/K	22	22
Power supply	V ~ Hz	230 1~ 50-60	115 1~ 50-60
Width - Height - Depth	mm	189 - 413 - 149	189 - 413 - 149
Max current	A	0.5	0.96
T Fuse	A	1	2
Power draw	W	72	80
Operating cycle	-	100%	100%
Electrical connection	-	Cable L = 3 m	Cable L = 3 m
External air fan capacity	m <sup>3</sup> /h	280	280
Cabinet air fan capacity	m <sup>3</sup> /h	280	280
Temperature limits	°C	-5+55	-5+55
EN60529 ingress protection - cabinet side	-	IP54	IP54
Noise level	dB (A)	59	60
Weight	kg	7	7
Conformity	-	CE	CE

# MIX36

## Air-air heat exchangers

SPECIFIC COOLING POWER 36 W/K



### PERFORMANCE

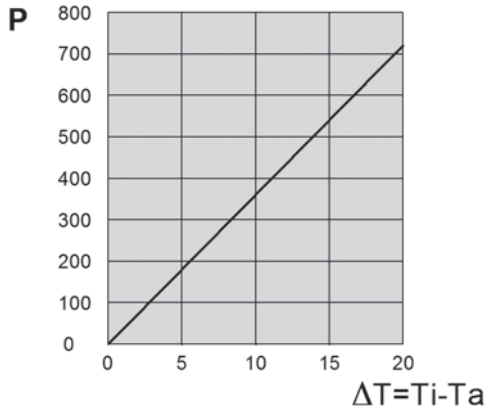

- P = Heating capacity (W)
- $\Delta T$  = Temperature differential (Tint-Tamb) (K)

### DIMENSIONS

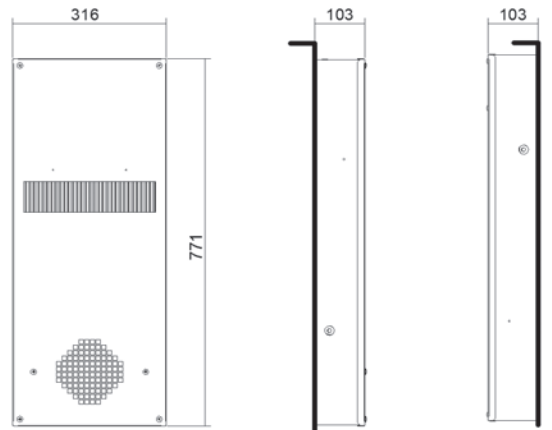

Features	UoM	MIX36BX0B	MIX36CX0B
Specific cooling power	W/K	36	36
Power supply	V ~ Hz	230 1~ 50-60	115 1~ 50-60
Width - Height - Depth	mm	316 - 771 - 103	316 - 771 - 103
Max current	A	0.64	1.12
T Fuse	A	1	2
Power draw	W	160	150
Operating cycle	-	100%	100%
Electrical connection	-	Cable L = 3 m	Cable L = 3 m
External air fan capacity	m <sup>3</sup> /h	570	570
Cabinet air fan capacity	m <sup>3</sup> /h	570	570
Temperature limits	°C	-5+55	-5+55
EN60529 ingress protection - cabinet side	-	IP54	IP54
Noise level	dB (A)	67	67
Weight	kg	10	10
Conformity	-	CE	CE

# MIX50

## Air-air heat exchangers

SPECIFIC COOLING POWER 50 W/K



### PERFORMANCE

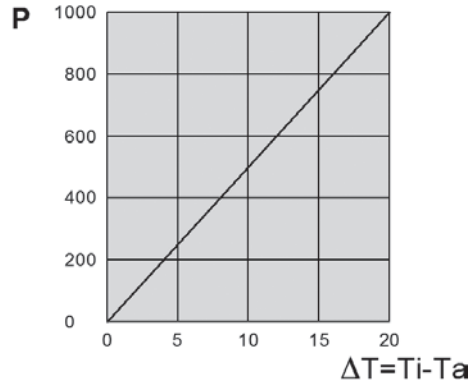

- P = Heating capacity (W)
- ΔT = Temperature differential (Tint-Tamb) (K)

### DIMENSIONS

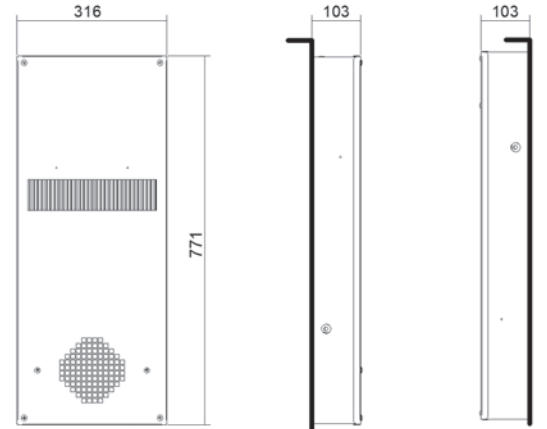

Features	UoM	MIX50BX0B	MIX50CX0B
Specific cooling power	W/K	50	50
Power supply	V ~ Hz	230 1~ 50-60	115 1~ 50-60
Width - Height - Depth	mm	316 - 771 - 103	316 - 771 - 103
Max current	A	0.64	1.12
T Fuse	A	1	2
Power draw	W	160	150
Operating cycle	-	100%	100%
Electrical connection	-	Cable L = 3 m	Cable L = 3 m
External air fan capacity	m <sup>3</sup> /h	600	600
Cabinet air fan capacity	m <sup>3</sup> /h	600	600
Temperature limits	°C	-5+55	-5+55
EN60529 ingress protection - cabinet side	-	IP54	IP54
Noise level	dB (A)	67	67
Weight	kg	10	10
Conformity	-	CE	CE



# MIX80

## Air-air heat exchangers

SPECIFIC COOLING POWER 80 W/K



### PERFORMANCE

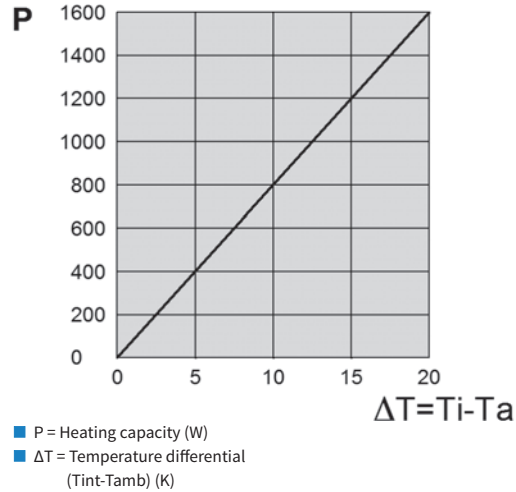

### DIMENSIONS

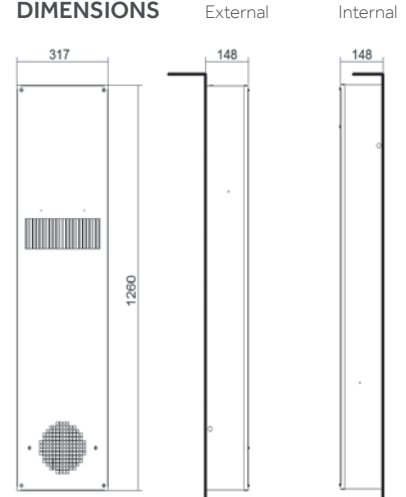

Features	UoM	MIX80BX0B	MIX80CX0B
Specific cooling power	W/K	80	80
Power supply	V ~ Hz	230 1~ 50-60	115 1~ 50-60
Width - Height - Depth	mm	317 - 1260 - 148	317 - 1260 - 148
Max current	A	1.06	2.1
T Fuse	A	2	4
Power draw	W	240	255
Operating cycle	-	100%	100%
Electrical connection	-	Cable L = 3 m	Cable L = 3 m
External air fan capacity	m <sup>3</sup> /h	1050	1050
Cabinet air fan capacity	m <sup>3</sup> /h	1050	1050
Temperature limits	°C	-5+55	-5+55
EN60529 ingress protection - cabinet side	-	IP54	IP54
Noise level	dB (A)	75	75
Weight	kg	17	17
Conformity	-	CE	CE

# FAN

## Ventilation units with filter

Quick installation and simple maintenance: the FAN range is **texa industries'** product range for electrical cabinet ventilation.

### WIDE RANGE OF AIR FLOW RATES

Air flow rates range from 36 to 920 m<sup>3</sup>/h. The standard air flow direction is from the exterior to the interior of the cabinet for all ventilation units. The user can easily invert this by simply removing and reinstalling the fan in the reverse direction.

### REDUCED EXTERNAL SIZE

The external projection is just 5 mm, in order to eliminate operational problems during transport and use of the cabinet due to excessive external dimensions.

### DESIGN

The grille and fan support system are made of extremely tough, self-extinguishing impact-resistant ABS, which meets UL94 V0 requirements. The standard colour is RAL 7035.

### QUICK INSTALLATION

Installation is made extremely fast by the simplicity of the square cut to be made on the cabinet panel and by the snap fastening system which does not require fastening screws. The snap fastening system can be used on panels between 1.2 mm and 2.4 mm thick. For thicknesses outside these limits, fastening can still be performed using the pack of screws included in all packs for this eventuality.

### HIGH RELIABILITY

The fans used are all with bearings. High quality and with high volumetric efficiency, they have an expected lifetime of 30,000 hours at an ambient temperature of 55 °C. They all feature provision for making easy and safe electrical connections.

### FILTER UNIT

FAN units can be used together with FIL filter meshes for expulsion of the air from the cabinet. Available in four sizes and created as the external part of the FAN unit, they allow the hot air to be expelled from the cabinet while maintaining its ingress protection rating.



# FAN08

## Ventilation units with filter

AIR FLOW RATE

36/41 - 44 m<sup>3</sup>/h

## PERFORMANCE

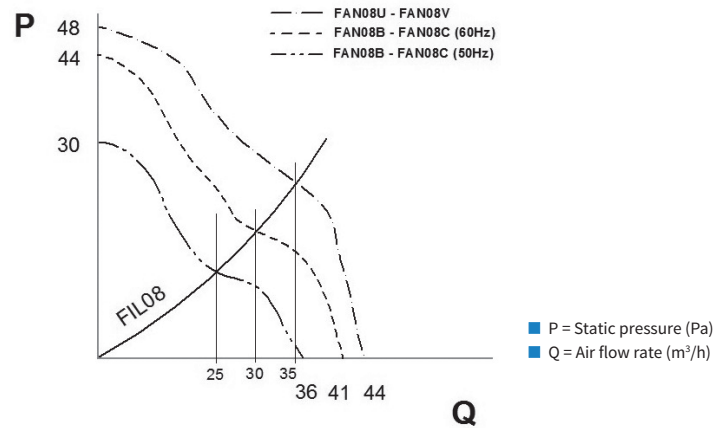

## DIMENSIONS

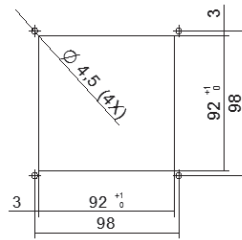
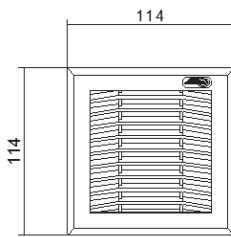

## FAN08

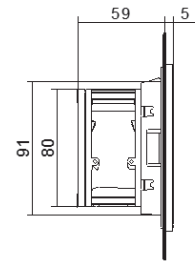

## FIL08

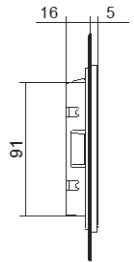

DRILLING TEMPLATE

N.B.: The drilling templates are only approximate.  
For any requirements, contact our technical/sales office.

Features	UoM	FIL08XN0B	FAN08BN0B	FAN08CN0B	FAN08UN0B	FAN08VN0B
Air flow rate	m <sup>3</sup> /h	-	36 - 41	36 - 41	44	44
Power supply	V ~ Hz	-	230 1~ 50-60	115 1~ 50-60	24 V DC	48 V DC
Dimensions HxWxD	mm	114x114x21	114x114x64	114x114x64	114x114x64	114x114x64
Power draw	W	-	15 - 13	15 - 12	5	6
Max current	A	-	0.14 - 0.13	0.07 - 0.06	0.18	0.12
Electrical connection	-	-	Faston	Faston	Faston	Faston
Temperature limits	°C	-30+75	-10+50	-10+50	-10+50	-10+50
IP rating EN60529	-	IP54	IP54	IP54	IP54	IP54
Noise level	dB (A)	-	30 - 32	30 - 32	36	36
FAN + FIL air flow rate	m <sup>3</sup> /h	-	1x FIL08XN0B: 25 - 30 1x FIL12XN0B: 28 - 33		1x FIL08XN0B: 35 1x FIL12XN0B: 38	
Filter (Eurovent)	-	EU4	EU4	EU4	EU4	EU4
Weight	kg	0.1	0.5	0.5	0.5	0.5
Conformity	-	CE	CE	CE	CE	CE

# FAN12

## Ventilation units with filter

AIR FLOW RATE

57/61 - 60 m<sup>3</sup>/h



### PERFORMANCE

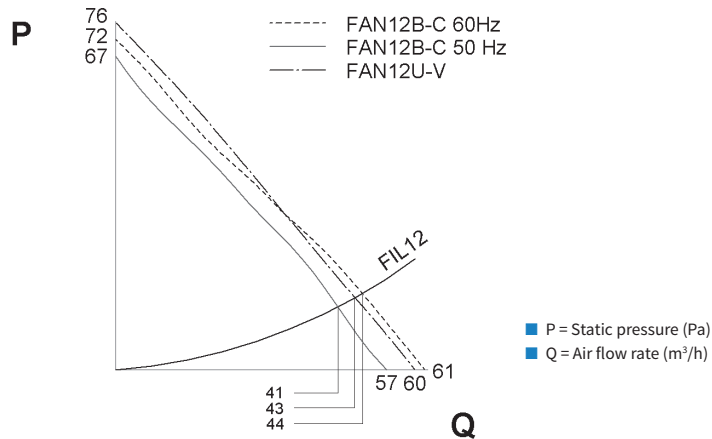

### DIMENSIONS

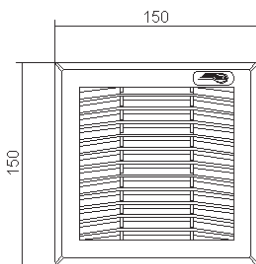

DRILLING TEMPLATE

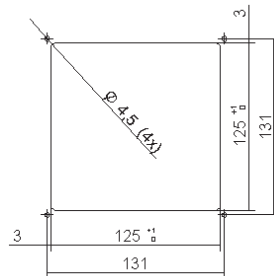

FAN08

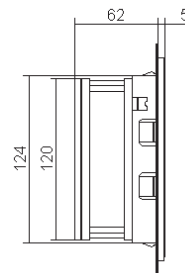

FIL08

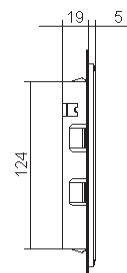

N.B.: The drilling templates are only approximate.  
For any requirements, contact our technical/sales office.

Features	UoM	FIL12XN0B	FAN12BN0B	FAN12CN0B	FAN12UN0B	FAN12VN0B
Air flow rate	m <sup>3</sup> /h	-	57 - 61	57 - 61	60	60
Power supply	V ~ Hz	-	230 1~ 50-60	115 1~ 50-60	24 V DC	48 V DC
Dimensions HxWxD	mm	150x150x24	150x150x67	150x150x67	150x150x67	150x150x67
Power draw	W	-	21 - 18	21 - 18	7	9
Max current	A	-	0.13 - 0.11	0.28 - 0.22	0.26	0.18
Electrical connection	-	-	Faston	Faston	Faston	Faston
Temperature limits	°C	-30+75	-10+50	-10+50	-10+50	-10+55
IP rating EN60529	-	IP54	IP54	IP54	IP54	IP54
Noise level	dB (A)	-	43 - 48	43 - 48	43	43
FAN + FIL air flow rate	m <sup>3</sup> /h	-	1xFIL12XN0B: 41 - 44 1xFIL25XN0B: 47 - 51		1xFIL12XN0B: 43 1xFIL25XN0B: 49	
Filter (Eurovent)	-	EU4	EU4	EU4	EU4	EU4
Weight	kg	0.1	0.7	0.7	0.7	0.7
Conformity	-	CE	CE	CE	CE	CE

# FAN23

## Ventilation units with filter

AIR FLOW RATE

115/125 - 120 m<sup>3</sup>/h



### PERFORMANCE

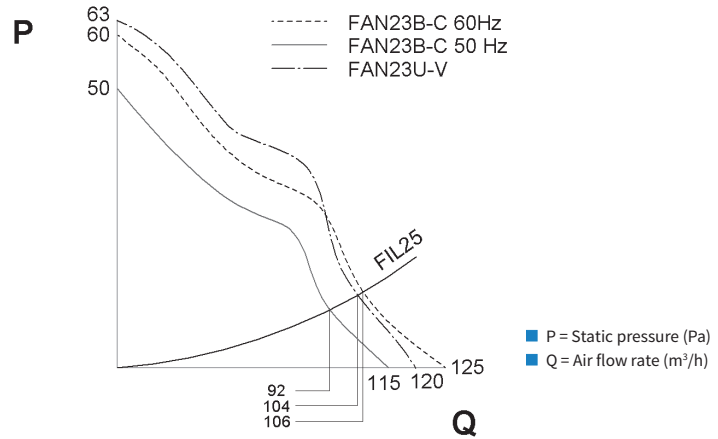

### DIMENSIONS

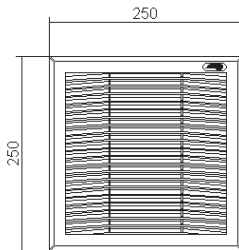

DRILLING TEMPLATE

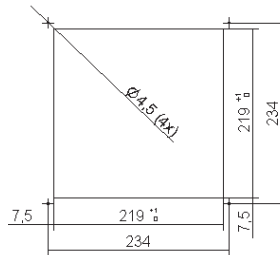

FAN23

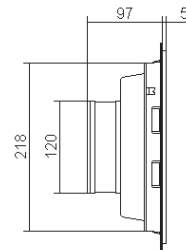

FIL25

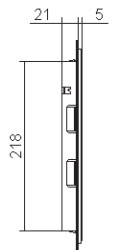

N.B.: The drilling templates are only approximate. For any requirements, contact our technical/sales office.

Features	UoM	FIL25XN0B	FAN23BN0B	FAN23CN0B	FAN23UN0B	FAN23VN0B
Air flow rate	m <sup>3</sup> /h	-	115 - 125	115 - 125	120	120
Power supply	V ~ Hz	-	230 1~ 50-60	115 1~ 50-60	24 V DC	48 V DC
Dimensions HxWxD	mm	250x250x26	250x250x102	250x250x102	250x250x102	250x250x102
Power draw	W	-	21 - 18	21 - 18	7	9
Max current	A	-	0.13 - 0.11	0.28 - 0.22	0.26	0.18
Electrical connection	-	-	Faston	Faston	Faston	Faston
Temperature limits	°C	-30+75	-10+50	-10+50	-10+50	-10+55
IP rating EN60529	-	IP54	IP54	IP54	IP54	IP54
Noise level	dB (A)	-	43 - 48	43 - 48	43	43
FAN + FIL air flow rate	m <sup>3</sup> /h	-	1x FIL25XN0B: 92 - 106 1x FIL35XN0B: 101 - 111		1x FIL25XN0B: 104 1x FIL35XN0B: 111	
Filter (Eurovent)	-	EU4	EU4	EU4	EU4	EU4
Weight	kg	0.4	1.1	1.1	1.1	1.1
Conformity	-	CE	CE	CE	CE	CE

# FAN25

## Ventilation units with filter

AIR FLOW RATE

230/262 - 230 m<sup>3</sup>/h



### PERFORMANCE

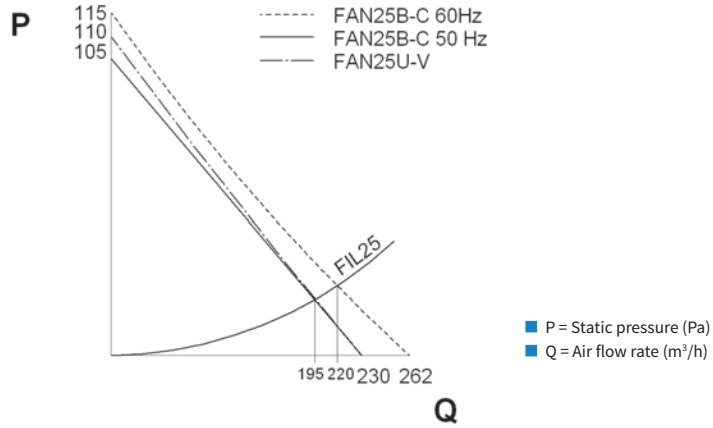

### DIMENSIONS

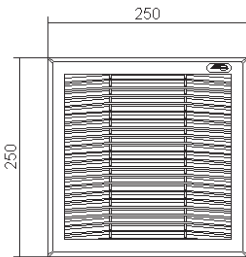

DRILLING TEMPLATE

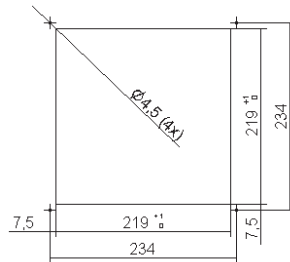

FAN25

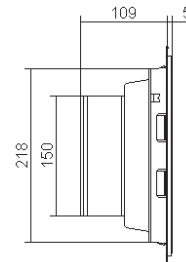

FIL25

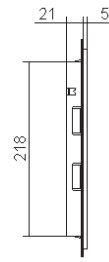

N.B.: The drilling templates are only approximate.  
For any requirements, contact our technical/sales office.

Features	UoM	FIL25XN0B	FAN25BN0B	FAN25CN0B	FAN25UN0B	FAN25VN0B
Air flow rate	m <sup>3</sup> /h	-	230 - 262	230 - 262	230	230
Power supply	V - Hz	-	230 1~ 50-60	115 1~ 50-60	24 V DC	48 V DC
Dimensions HxWxD	mm	250x250x26	250x250x114	250x250x114	250x250x114	250x250x114
Power draw	W	-	45 - 40	45 - 40	23	20
Max current	A	-	0.35 - 0.28	0.65 - 0.55	0.95	0.42
Electrical connection	-	-	Faston	Faston	Faston	Faston
Temperature limits	°C	-30+75	-10+50	-10+50	-10+50	-10+55
IP rating EN60529	-	IP54	IP54	IP54	IP54	IP54
Noise level	dB (A)	-	56 - 58	56 - 58	50	50
FAN + FIL air flow rate	m <sup>3</sup> /h	-	1x FIL25XN0B: 195 - 220 2x FIL25XN0B: 215 - 233 1x FIL35XN0B: 205 - 228		1x FIL25XN0B: 195 2x FIL25XN0B: 215 1x FIL35XN0B: 205	
Filter (Eurovent)	-	EU4	EU4	EU4	EU4	EU4
Weight	kg	0.4	1.4	1.4	1.4	1.4
Conformity	-	CE	CE	CE	CE	CE

## Ventilation units with filter

AIR FLOW RATE

400/440 m<sup>3</sup>/h

## PERFORMANCE

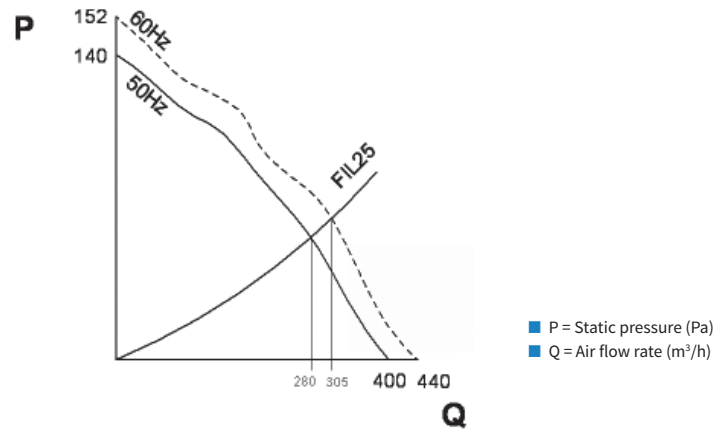

## DIMENSIONS

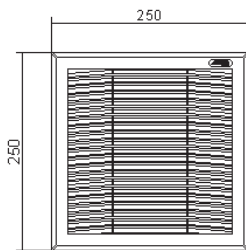

DRILLING TEMPLATE

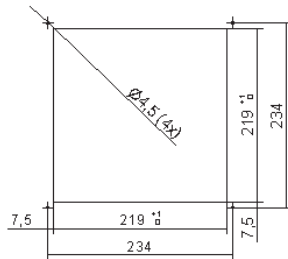

FAN28

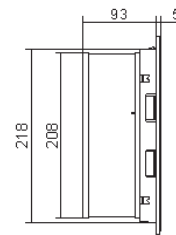

FIL25

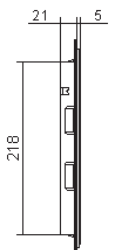

N.B.: The drilling templates are only approximate.  
For any requirements, contact our technical/sales office.

Features	UoM	FIL25XN0B	FAN28BN0B	FAN28CN0B	FAN28LN0B
Air flow rate	m <sup>3</sup> /h	-	400 - 440	400 - 440	400 - 440
Power supply	V - Hz	-	230 1~ 50-60	115 1~ 50-60	400 3~ 50-60
Dimensions HxWxD	mm	250x250x26	250x250x98	250x250x98	250x250x98
Power draw	W	-	85 - 115	85 - 115	85 - 115
Max current	A	-	0.38 - 0.50	0.70 - 0.90	0.18 - 0.18
Electrical connection	-	-	Faston	Faston	Terminal board
Temperature limits	°C	-30+75	-10+50	-10+50	-10+50
IP rating EN60529	-	IP54	IP54	IP54	IP54
Noise level	dB (A)	-	61 - 63	61 - 63	61 - 63
FAN + FIL air flow rate	m <sup>3</sup> /h	-	1x FIL25XN0B: 280 - 305 2x FIL25XN0B: 297 - 318 1x FIL35XN0B: 308 - 332		
Filter (Eurovent)	-	EU4	EU4	EU4	EU4
Weight	kg	0.4	2.7	2.7	2.7
Conformity	-	CE	CE	CE	CE



# FAN35

## Ventilation units with filter

AIR FLOW RATE

520/580 m<sup>3</sup>/h



### PERFORMANCE

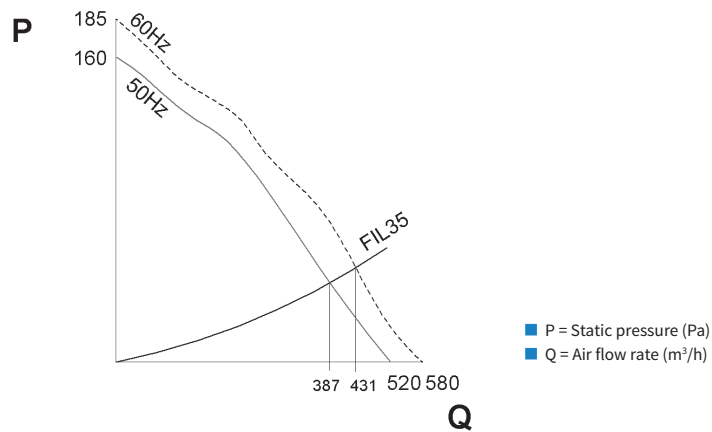

### DIMENSIONS

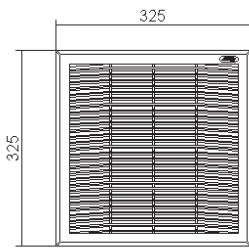

DRILLING TEMPLATE

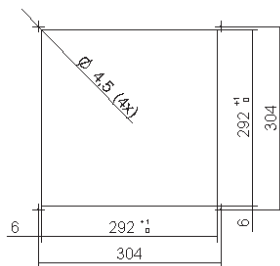

FAN35

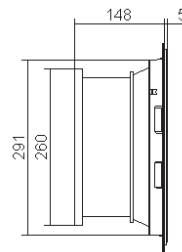

FIL35

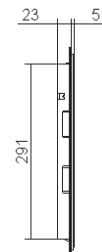

N.B.: The drilling templates are only approximate.  
For any requirements, contact our technical/sales office.

Features	UoM	FIL35XN0B	FAN35BN0B	FAN35CN0B	FAN35LN0B
Air flow rate	m <sup>3</sup> /h	-	520 - 580	520 - 580	520 - 580
Power supply	V - Hz	-	230 1~ 50-60	115 1~ 50-60	400 3~ 50-60
Dimensions HxWxD	mm	325x325x28	325x325x153	325x325x153	325x325x153
Power draw	W	-	85 - 115	85 - 115	85 - 115
Max current	A	-	0.38 - 0.50	0.70 - 0.90	0.18 - 0.18
Electrical connection	-	-	Faston	Faston	Terminal board
Temperature limits	°C	-30+75	-10+50	-10+50	-10+50
IP rating EN60529	-	IP54	IP54	IP54	IP54
Noise level	dB (A)	-	61 - 63	61 - 63	61 - 63
FAN + FIL air flow rate	m <sup>3</sup> /h	-	1xFIL35XN0B: 387 - 431	1xFIL35XN0B: 387 - 431	1xFIL35XN0B: 387 - 431
Filter (Eurovent)	-	EU4	EU4	EU4	EU4
Weight	kg	0.6	3.1	3.1	3.1
Conformity	-	CE	CE	CE	CE

# FAN39

## Ventilation units with filter

AIR FLOW RATE

920/940 m<sup>3</sup>/h

## PERFORMANCE

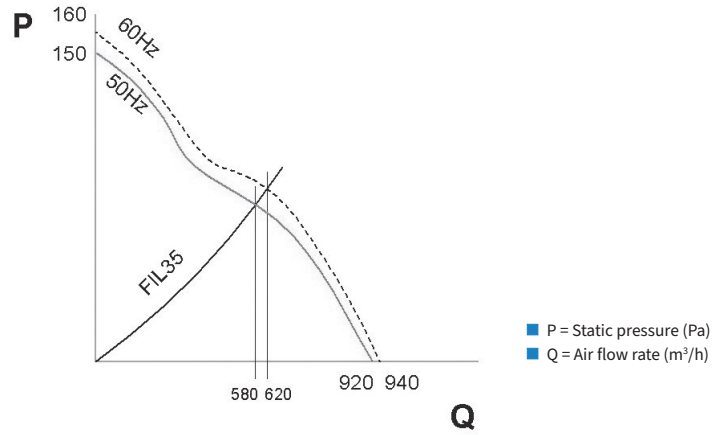

## DIMENSIONS

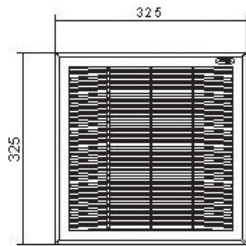

DRILLING TEMPLATE

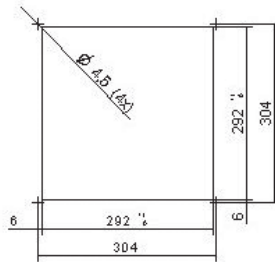

## FAN39

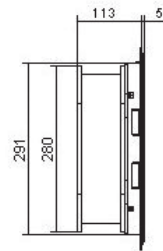

## FIL35

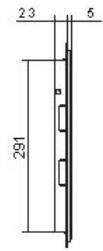

N.B.: The drilling templates are only approximate.  
For any requirements, contact our technical/sales office.

Features	UoM	FIL35XN0B	FAN39BN0B	FAN39CN0B
Air flow rate	m <sup>3</sup> /h	-	920 - 940	920 - 940
Power supply	V ~ Hz	-	230 1~ 50-60	115 1~ 50-60
Dimensions HxWxD	mm	325x325x28	325x325x118	325x325x118
Power draw	W	-	140/190	112/146
Max current	A	-	0.62/0.86	1.20/1.35
Electrical connection	-	-	Terminal board	Terminal board
Temperature limits	°C	-30+75	-10+50	-10+50
IP rating EN60529	-	IP54	IP54	IP54
Noise level	dB (A)	-	65 - 68	65 - 68
FAN + FIL air flow rate	m <sup>3</sup> /h	-	1x FIL35XN0B: 580 - 620	1x FIL35XN0B: 580 - 620
Filter (Eurovent)	-	EU4	EU4	EU4
Weight	kg	0.6	4.8	4.8
Conformity	-	CE	CE	CE

## FILTERS



Models	Item code	Quantity per pack
FAN08-FIL08	AAFFN08	10
FAN12-FIL12	AAFFN12	10
FAN23-FAN25-FAN28-FIL25	AAFFN25	10
FAN35-FAN39-FIL35	AAFFN35	10

### AAFFN

#### Replacement fabric filters for FAN units

These are the standard fabric filters for the FAN units. To keep the performance of these fan units as high as possible, it is necessary to regularly check the level of clogging of the fabric filters, replacing them with new ones when necessary. The fabric filters are made from self-extinguishing synthetic fibres, with a tight weave and with progressive filtration power. The filtration efficiency can reach 91%. Level of filtration EU4.



Models	Item code	Quantity per pack
FAN08-FIL08	AAFFH08	10
FAN12-FIL12	AAFFH12	10
FAN23-FAN25-FAN28-FIL25	AAFFH25	10
FAN35-FAN39-FIL35	AAFFH35	10

### AAFFH

#### High-efficiency fabric filters

These high-efficiency fabric filters are used for environments with fine dust. Using these fabric filters increases the degree of protection of the fan units, however the air flow rate is reduced from the nominal capacity. The filtration efficiency can reach 97%. Level of filtration EU5.

# DLK

## Ventilating towers

A tough frame combined with an attractive design set the DLK range of roof ventilators apart.

### APPLICATION

Featuring easy installation and an attractive, innovative design, the DLK range of roof ventilation towers are the ideal solution when there is no space on the cabinet walls, or the air flow is higher than that available with the FAN range of ventilated grilles.

### AVAILABLE AIR FLOW RATES

Available in 6 sizes: from 600 to 4000 m<sup>3</sup>/h. The fans used are all radial models with bearings. High quality and with high volumetric efficiency, they have an expected lifetime of 50,000 hours at an ambient temperature of 40 °C.

### HIGH IP RATING

The special configuration of the covering structure and the self-adhesive seal for coupling to the enclosure allow DLK/DLR units to achieve an IP44 rating. On request, a filter kit is available which allows an IP54 rating to be achieved.

### NATURAL VENTILATION UNIT

A version without fan is also available: DLR19XX0B. This is used when natural ventilation is sufficient to cool the cabinet and you wish to maintain a high IP rating for the cabinet.

### AVAILABLE POWER SUPPLIES

DLK ventilation towers are available for 230V and 115V single-phase power supplies. On request, versions for supply voltages not present in the catalogue can be produced for orders of sufficient quantities.

### FILTER UNIT

DLK ventilating towers can be used together with the FIL35XN0B filter grille for intake of air in the cabinet.



# DLK19-22-25

## Ventilating towers

AIR FLOW RATE

600/625 - 1050/1085 - 1380/1460 m<sup>3</sup>/h

## DIMENSIONS

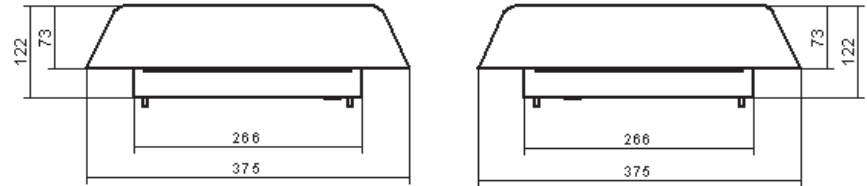

## PERFORMANCE

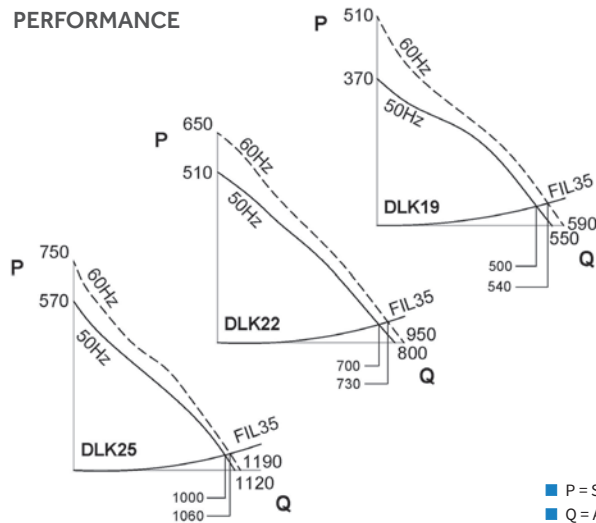

## DRILLING TEMPLATE

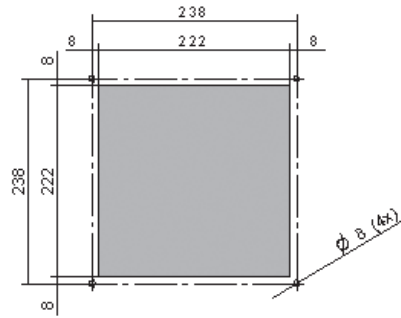

N.B.: The drilling templates are only approximate.  
For any requirements, contact our technical/sales office.

Features	UoM	DLR19XX0B	DLK19BX0B	DLK19CX0B	DLK22BX0B	DLK22CX0B	DLK25BX0B
Air flow rate	m <sup>3</sup> /h	-	600 - 625	600 - 625	1050 - 1085	1050 - 1085	1380 - 1460
Fan+tower air flow capacity	m <sup>3</sup> /h	-	550 - 590	550 - 590	800 - 950	800 - 950	1120 - 1190
Power supply	V ~ Hz	-	230 1~ 50-60	115 1~ 50-60	230 1~ 50-60	115 1~ 50-60	230 1~ 50-60
Dimensions HxWxD	mm	122x375x375	122x375x375	122x375x375	122x375x375	122x375x375	122x375x375
Power draw	W	-	78 - 106	58 - 77	123 - 168	143 - 200	135 - 200
Max current	A	-	0.32 - 0.4	0.58 - 0.73	0.52 - 0.65	1.13 - 1.42	0.6 - 0.88
Electrical connection	-	-	Cable	Cable	Cable	Cable	Cable
Temperature limits	°C	-20+60	-20+60	-20+60	-20+60	-20+60	-20+60
IP rating EN60529	-	IP44	IP44	IP44	IP44	IP44	IP44
Noise level	dB (A)	-	62 - 64	62 - 64	72 - 71	72 - 71	70 - 72
DLK + FIL35XN0B air flow capacity	m <sup>3</sup> /h	-	500 - 540	500 - 540	700 - 730	700 - 730	1000 - 1060
Weight	kg	4	6	6	7	7	7
Conformity	-	CE	CE	CE	CE	CE	CE

# DLK42-45-48

## Ventilating towers

AIR FLOW RATE

2300/2530 - 3000/3370 - 4000/4520 m<sup>3</sup>/h

### DIMENSIONS

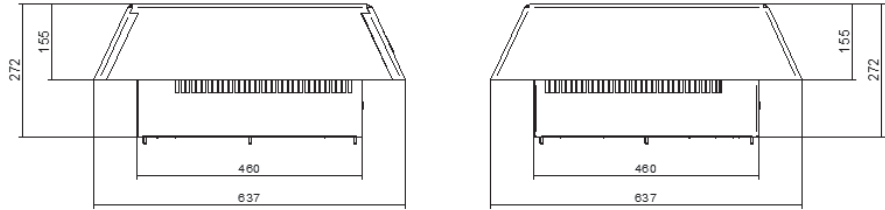

### PERFORMANCE

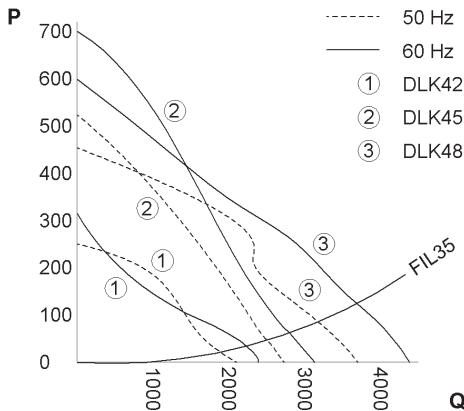

■ P = Static pressure (Pa)  
■ Q = Air flow rate (m<sup>3</sup>/h)

### DRILLING TEMPLATE

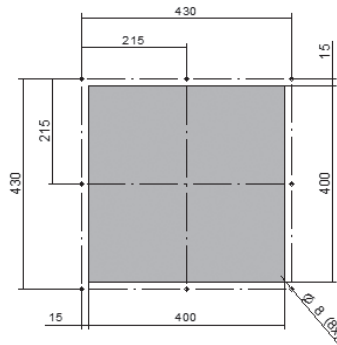

N.B.: The drilling templates are only approximate.  
For any requirements, contact our technical/sales office.

Features	UoM	DLR42XX0B	DLK42BX0B	DLK45BX0B	DLK48BX0B
Fan air flow capacity	m <sup>3</sup> /h	-	2300 - 2530	3000 - 3370	4000 - 4520
Fan+tower air flow capacity	m <sup>3</sup> /h	-	2110 - 2390	2750 - 3180	3670 - 4270
Power supply	V - Hz	-	230 1~ 50-60	230 1~ 50-60	230 1~ 50-60
Dimensions HxWxD	mm	272x637x637	272x637x637	272x637x637	272x637x637
Power draw	W	-	240 - 340	290 - 390	340 - 420
Max current	A	-	0.9 - 1.1	1.2 - 1.4	1.7 - 1.8
Electrical connection	-	-	Cable	Cable	Cable
Temperature limits	°C	-20+60	-20+60	-20+60	-20+60
IP rating EN60529	-	IP44	IP44	IP44	IP44
Noise level	dB (A)	-	62 - 64	72 - 74	71 - 74
DLK + 6 FIL35XN0B air flow capacity	m <sup>3</sup> /h	-	1920 - 2200	2520 - 2930	3340 - 3930
Weight	kg	17	27	27	27
Conformity	-	CE	CE	CE	CE

# WID

## Anti-condensation heaters

Compatible, reliable and safe. The WID range offers a huge range of solutions for electrical cabinet heating.

### APPLICATION

Heaters are required to prevent faults or corrosion due to excessively low temperatures or high humidity levels inside the cabinet. These conditions can occur when the ambient temperature is low and the equipment inside the cabinet is not powered or does not dissipate sufficient heat to keep the internal temperature above a minimum threshold. Outdoor cabinets are almost always found in these conditions.

### SAFETY

The surface temperature is limited via PTC. This allows for safe operation and self-regulated heating power. All heaters are Class I except for the WID..ZX0P and WID..BL0T range of heaters, which are Class II.

### SPEED OF INSTALLATION

Installation is quick and easy. All units have provision for snap-on installation onto 35 mm EN 50022 DIN rail.

### LONG LIFE

The fan heaters are equipped with fans with bearings. They have an expected lifetime of 50,000 hours at an ambient temperature of 25 °C.

### FLEXIBLE POWER SUPPLY

The WID range of heaters in the catalogue have the following power supplies:

WID..ZX0X	110-250 V AC/DC	WID..BL0C	230 V 50/60 Hz
WID..ZX0P	110-250 V AC/DC	WID..BL0T	230 V 50/60 Hz

### WIDE RANGE

Compact, reliable and high performance, WID series heaters cover a range of heating outputs from 10 to 550 W and are available in four types:

WID..ZX0X	Standard	WID..BL0C	Compact fan
WID..ZX0P	Protected surface	WID..BL0T	Fan with integrated thermostat





# WID01÷03ZX0P

## Anti-condensate heaters with protected surface

HEATING POWER

10 - 20 - 30 W

## DIMENSIONS

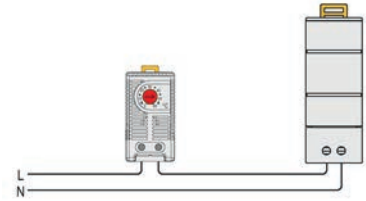
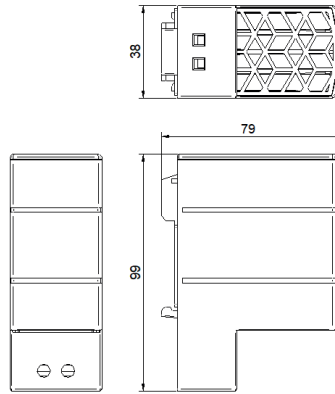

CONNECTION EXAMPLES

Features	UoM	WID01ZX0P	WID02ZX0P	WID03ZX0P
Heating power*	W	10	20	30
Power supply	V ~ Hz	110-250 V AC/DC	110-250 V AC/DC	110-250 V AC/DC
Dimensions HxWxD	mm	99x38x79	99x38x79	99x38x79
Max current	A	0.3	0.9	1.8
T Fuse	A	2	4	5
Heating element	-	self-regulated PTC	self-regulated PTC	self-regulated PTC
Electrical connection	-	Terminal board 2 poles	Terminal board 2 poles	Terminal board 2 poles
IEC protection class	-	II	II	II
IP rating EN60529	-	IP20	IP20	IP20
Enclosure	-	Plastic UL94 V-0	Plastic UL94 V-0	Plastic UL94 V-0
Clip installation for DIN rail	mm	35	35	35
Weight	kg	0.2	0.3	0.3
Conformity	-	CE	CE	CE

\* At 20 °C ambient temperature

# WID05÷15ZX0X

## Anti-condensation heaters

HEATING POWER

45 - 100 - 150 W

### DIMENSIONS

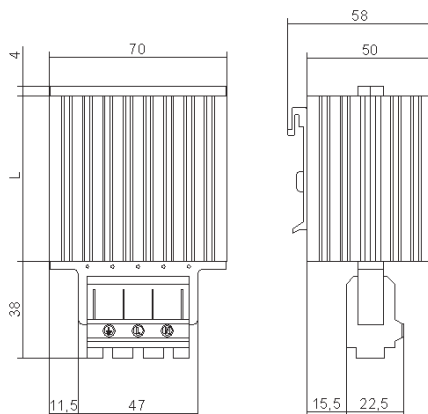

W mm	
WID05ZX0X	65
WID10ZX0X	140
WID15ZX0X	220

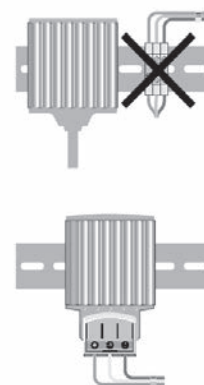

FACILITATED INSTALLATION  
WITH QUICK-CONNECTION  
TERMINALS

Features	UoM	WID05ZX0X	WID10ZX0X	WID15ZX0X
Heating power*	W	45	100	150
Power supply	V ~ Hz	110-250 V AC/DC	110-250 V AC/DC	110-250 V AC/DC
Dimensions HxWxD	mm	109x70x50	184x70x50	264x70x50
Max current	A	3.5	4.5	9
Heating element	-	self-regulated PTC	self-regulated PTC	self-regulated PTC
Electrical connection	-	Terminal board 3 poles	Terminal board 3 poles	Terminal board 3 poles
IEC protection class	-	I	I	I
IP rating EN60529	-	IP20	IP20	IP20
Radiator	-	Extruded aluminium profile	Extruded aluminium profile	Extruded aluminium profile
Clip installation for DIN rail	mm	35	35	35
Weight	kg	0.3	0.5	0.7
Conformity	-	CE	CE	CE

\* At 20 °C ambient temperature

# WID05÷15ZX0P

## Anti-condensate heaters with protected surface

HEATING POWER

50 - 100 - 150 W

## DIMENSIONS

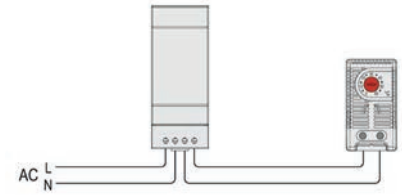
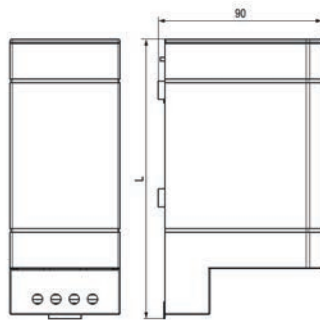
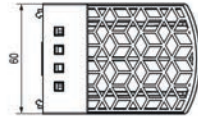

CONNECTION EXAMPLES

## W mm

WID05ZX0P	110
WID10ZX0P	150
WID15ZX0P	150

Features	UoM	WID05ZX0P	WID10ZX0P	WID15ZX0P
Heating power*	W	50	100	150
Power supply	V ~ Hz	110-250 V AC/DC	110-250 V AC/DC	110-250 V AC/DC
Dimensions HxWxD	mm	110x60x90	150x60x90	150x60x90
Max current	A	2.5	4.5	8
T Fuse	A	4	8	8
Heating element	-	self-regulated PTC	self-regulated PTC	self-regulated PTC
Electrical connection	-	Terminal board 4 poles	Terminal board 4 poles	Terminal board 4 poles
IEC protection class	-	II	II	II
IP rating EN60529	-	IP20	IP20	IP20
Enclosure	-	Plastic UL94 V-0	Plastic UL94 V-0	Plastic UL94 V-0
Clip installation for DIN rail	mm	35	35	35
Weight	kg	0.3	0.4	0.4
Conformity	-	CE	CE	CE

\* At 20 °C ambient temperature

# WID..BL0T

## Anti-condensate fan heaters with thermostat

HEATING POWER

350 - 550 W

### DIMENSIONS

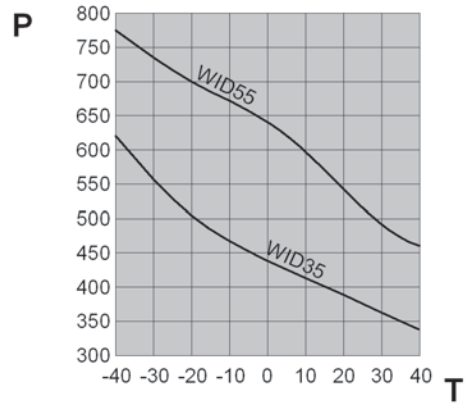
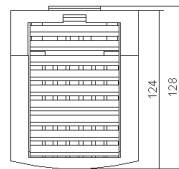
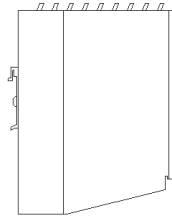
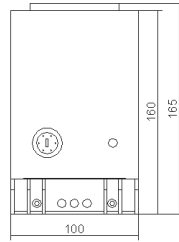

- P = Heating capacity (W)
- T = Temperature (°C)

Features	UoM	WID35BL0T	WID55BL0T
Heating power*	W	350	550
Power supply	V ~ Hz	230 1~ 50-60	230 1~ 50-60
Max current	A	11.0	13.0
Dimensions HxWxD	mm	165x100x128	165x100x128
Heating element	-	self-regulated PTC	self-regulated PTC
Fan Capacity	m <sup>3</sup> /h	35	35
Electrical protection	-	For fault on fan	For fault on fan
Temperature limits	°C	0-60	0-60
Electrical connection	-	Terminal board 2 poles	Terminal board 2 poles
IEC protection class	-	II	II
IP rating EN60529	-	IP20	IP20
Clip installation for DIN rail	mm	35	35
Weight	kg	0.9	1.1
Conformity	-	CE	CE

\* At 20 °C ambient temperature

# WID..BLOC

## Compact anti-condensate fan heaters

HEATING POWER

100 - 150 - 200 - 300 - 400 W

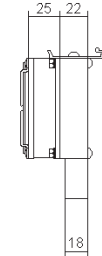
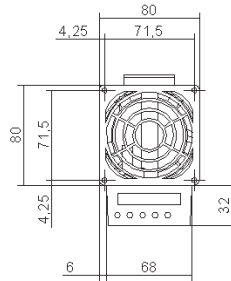
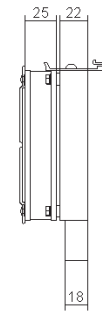
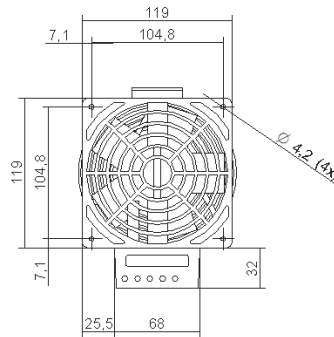
WID10BLOC  
WID15BLOCWID20BLOC  
WID30BLOC  
WID40BLOC

### DIMENSIONS

COMPOSITION OF THE  
HEATER-FAN ASSEMBLY

Features	UoM	WID10BLOC	WID15BLOC	WID20BLOC	WID30BLOC	WID40BLOC
Heating power	W	100	150	200	300	400
Power supply	V ~ Hz	230 1~ 50-60	230 1~ 50-60	230 1~ 50-60	230 1~ 50-60	230 1~ 50-60
Dimensions HxWxD	mm	112x80x47	112x80x47	151x119x47	151x119x47	151x119x47
Heating element	-	High-efficiency heater cartridge	High-efficiency heater cartridge	High-efficiency heater cartridge	High-efficiency heater cartridge	High-efficiency heater cartridge
Fan Capacity	m <sup>3</sup> /h	35	35	108	108	108
Electrical protection	-	For fault on fan	For fault on fan	For fault on fan	For fault on fan	For fault on fan
Outlet air temperature*	°C	45	45	45	45	45
Heating element electrical connection	-	Terminal board 3 poles	Terminal board 3 poles	Terminal board 3 poles	Terminal board 3 poles	Terminal board 3 poles
Fan electrical connection	-	Terminal board 2 poles	Terminal board 2 poles	Terminal board 2 poles	Terminal board 2 poles	Terminal board 2 poles
IEC protection class	-	I	I	I	I	I
IP rating EN60529	-	IP20	IP20	IP20	IP20	IP20
Radiator	-	Die-cast aluminium	Die-cast aluminium	Die-cast aluminium	Die-cast aluminium	Die-cast aluminium
Clip installation for DIN rail	mm	35	35	35	35	35
Weight	kg	0.6	0.6	0.9	0.9	0.9
Conformity	-	CE	CE	CE	CE	CE

\* 50 mm above element



# ACCESSORIES

## TWINNED THERMOSTAT



Features	UoM	C16000385
Field of regulation	°C	0+60/0+60
Contact	-	NC/NO
Contact capacity with resistive load	A	7
Max voltage	V	250 AC
Dimensions HxWxD	mm	67x50x46
Sensitive element	-	Bimetallic
Electrical connection	-	4-pole terminal board (2.5 mm <sup>2</sup> )
Operating temperature limit	°C	-45+80
IP rating EN60529	-	IP20
Clip installation for DIN rail	mm	35
Conformity	-	CE

### Accessories

Pack of 5 x device installation accessories for cabinets

-

AAWFT10

### C16000385

#### Twinned thermostat

Two thermostats in a single housing:

- A thermostat with normally closed contact for regulating heating devices.
- A thermostat with normally open contact for regulating fans with filter or heat exchangers.

A version with two normally open contacts is also available

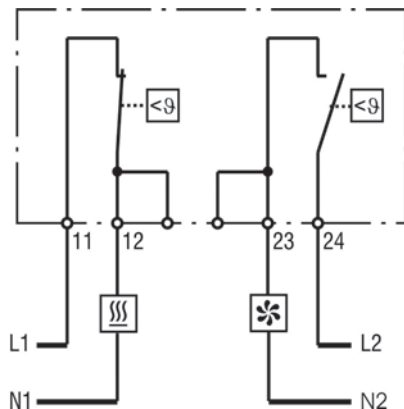

CONNECTION DIAGRAM

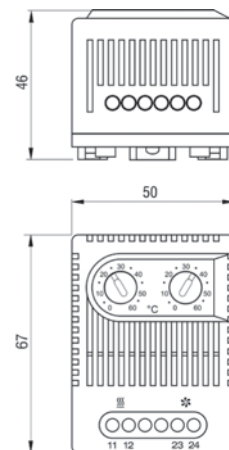



# ACCESSORIES

## THERMOSTAT



### AAWTC10 - AAFTO12

Compact thermostat, fast snap-on installation, with a wide field of regulation.

It has a normally closed/open contact and is used primarily for controlling anti-condensate heaters.

#### Accessories

Pack of 5 x device installation accessories for cabinets

- AAWFT10

Features	UoM	AAWTC10	AAFTO12
Field of regulation	°C	0-60	0-60
Activation differential	K	7	7
Contact	-	NC	NO
Contact capacity with resistive load	A	10	10
Max voltage	V	250 AC	250 AC
Dimensions HxWxD	mm	60x33x35	60x33x35
Sensitive element	-	Bimetallic	Bimetallic
Electrical connection	-	2-pole terminal board (2.5 mm <sup>2</sup> )	2-pole terminal board (2.5 mm <sup>2</sup> )
Operating temperature limit	°C	-45+80	-45+80
IP rating EN60529	-	IP20	IP20
Clip installation for DIN rail	mm	35	35
Conformity	-	CE	CE

THERMOSTAT  
AAWTC10

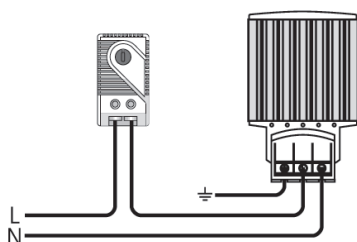

HEATING

THERMOSTAT  
AAFTO12

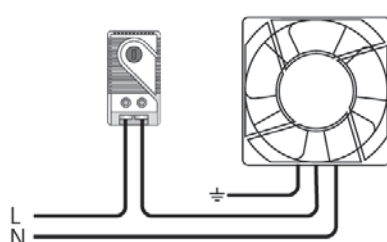

COOLING

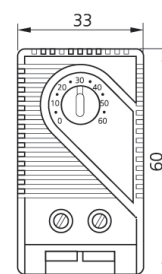
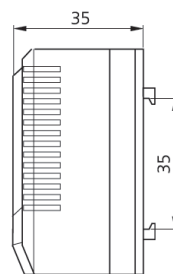

# ACCESSORIES

## THERMOSTAT



Features	UoM	AAWTS10
Field of regulation	°C	0-60
Activation differential	K	4.0
Contact	-	Change-over
Contact capacity with resistive load	A	10
Max voltage	V	240 AC
Dimensions HxWxD	mm	64x38x51
Sensitive element	-	Bimetallic
Electrical connection	-	3-pole terminal board (2.5 mm <sup>2</sup> )
Operating temperature limit	°C	-20+80
IP rating EN60529	-	IP20
Clip installation for DIN rail	mm	35
Conformity	-	CE

### Accessories

Pack of 5 x device installation accessories for cabinets	-	AAWFT10
--	---	---------

### AAWTS10

#### Thermostat

Thermostat with high current capacity change-over contact

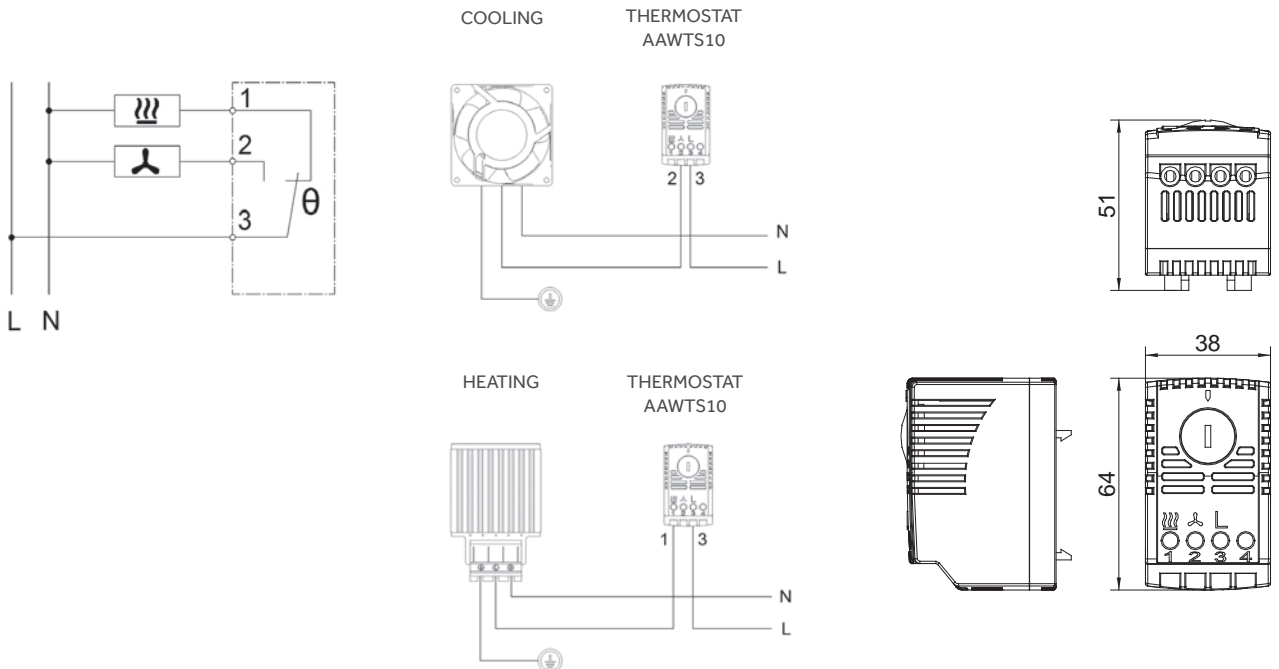

# ACCESSORIES

## HUMIDISTAT



Features	UoM	AAWHS10
Operating temperature	°C	0-60
Field of regulation	%RH	35-95
Activation differential	%RH	4
Contact	-	Change-over
Contact capacity with resistive load	A	5
Max voltage	V	250 AC
Dimensions HxWxD	mm	67x50x38
Max permissible air speed	m/s	15
Electrical connection	-	3-pole terminal board (2.5 mm <sup>2</sup> )
Operating temperature limit	°C	0+60
IP rating EN60529	-	IP20
Clip installation for DIN rail	mm	35
Conformity	-	CE

### Accessories

Pack of 5 x device installation accessories for cabinets

-

AAWFT10

## AAWHS10

### Humidistat

Humidistat which allows the formation of condensation to be prevented, protecting the inside of the cabinet from the resulting inevitable damage. Used to control anti-condensate heaters or dehumidifiers. Features a change-over contact with high switching power.

LOAD 2 = ELECTRICAL CABINET HEATING  
LOAD 3 = DEHUMIDIFIER

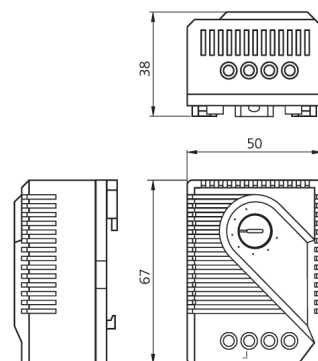
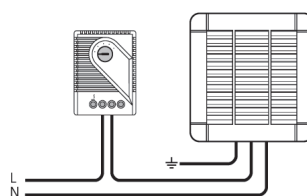
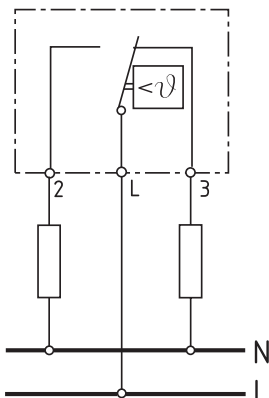

# ACCESSORIES

## LED LIGHT



Features	UoM	AALGT10
Power supply	V - Hz	100-240 V AC, 50/60Hz (min. 90 V AC, max. 265 V AC)
Power draw	W	Max. 5
Luminous flux	Lm	290 Lm at 120° (corresponding to 870 Lm at 360° or 75W for an incandescent bulb)
Light bulb	-	LED, angle of irradiation 120°
Lifetime	h	60,000 h at +20°C (+68 °F)
Connection	-	Two-pin locking plug AC: max. 2,5 A/240 V AC, colour: white
Fastening	-	Magnetic fastening
Housing	-	Plastic, transparent
Dimensions	mm	351x34x32
Weight	g	200
Operating ambient temp.	°C - °F	-30°C - +60°C (-22°F - +140°F)
Storage ambient temp.	°C - °F	-40°C - +85°C (-40°F - +185°F)
Operating/storage ambient humidity	%RH	max. 90% RH (non-condensing)
Protection type/protection class	IP	IP20/II (double insulated)

### AALGT10

#### LED light with magnetic fastening

The AALGT10 range of lights can be used in all types of cabinets or panels, even where space is extremely limited. The magnetic fastening, the integrated power supply and the locking input and output plugs make installation quick, flexible and safe. Up to 10 lights can be connected in series.

LED technology guarantees a very long lamp lifetime.

**FEMALE PLUG**  
FOR POWER SUPPLY CABLE.



**MALE PLUG**  
ONLY FOR CONNECTING MULTIPLE  
LIGHTS IN SERIES (MAX 10).

**LED LAMP AALGT10**

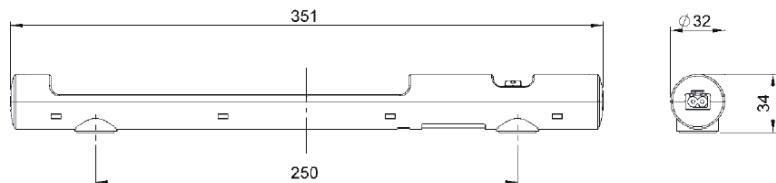



# Refrigeration range

High-precision and high-energy efficiency  
industrial chillers.

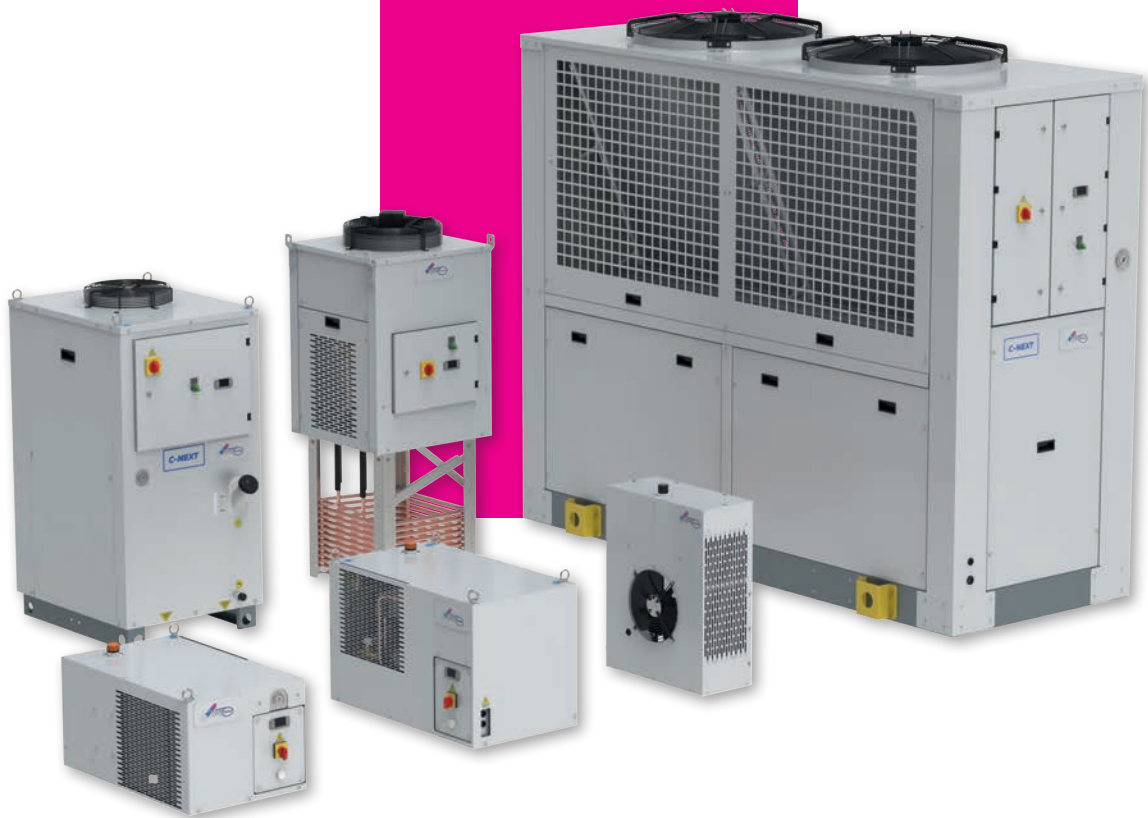

# At the heart of technology

## There are numerous reasons to choose a texa industries cooling system

An attention to detail, a huge range of optional accessories and impressive reliability are the key characteristics which set **texa industries industrial chillers** apart.

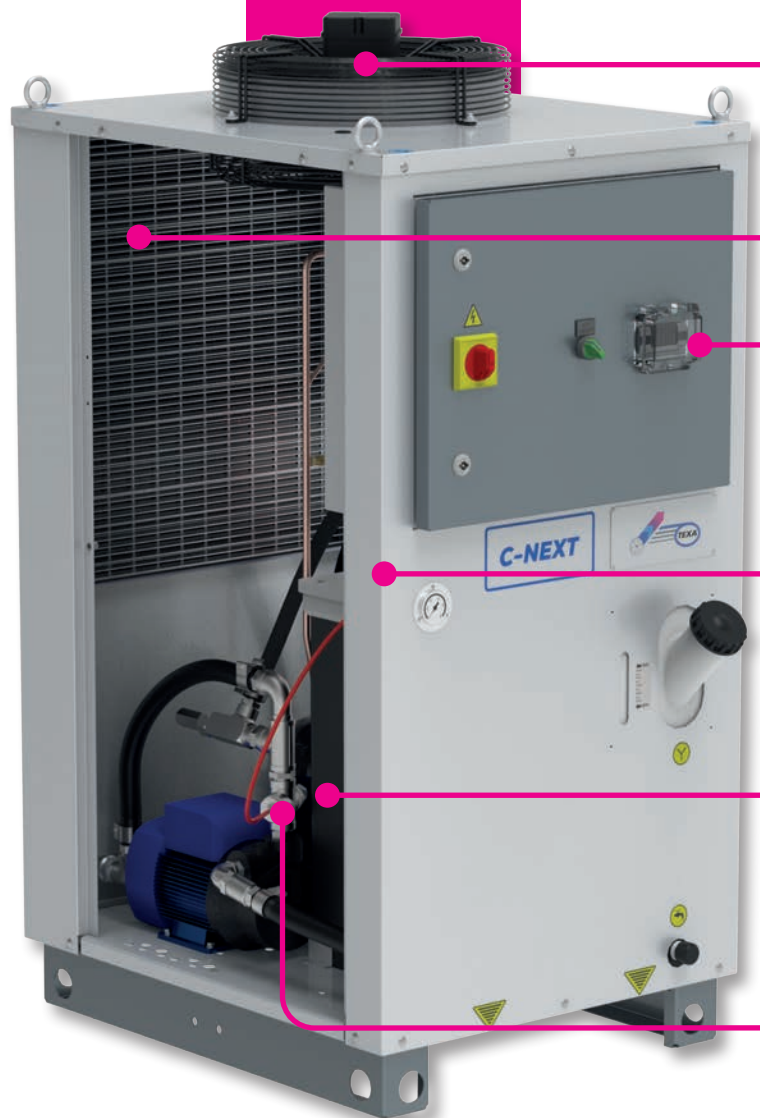





## OUTDOOR KIT

All chillers of the C-NEXT range can be provided for installation outdoors with operating limits of  $-5^{\circ}\text{C}$  or  $-20^{\circ}\text{C}$ .



## NEGATIVE COLD

Where temperatures of the cooling medium of as low as  $-5^{\circ}\text{C}$  are required, we offer a specific range of chillers borne from our experience in the food and industrial sectors.



## EC FANS

The entire C-NEXT range can be provided with electronically commutated EC fans that ensure extremely high performance levels and low energy use.



## MICROCHANNEL CONDENSERS

The C-NEXT range was developed with the use of all-aluminium microchannel condensers, a technology that maximises efficiency and reduces the amount of refrigerant.



## FLEXIBILITY

The C-NEXT range is designed for over 40 configuration options, whether UL-certified electrical cabinet or stainless steel framework. We ensure customers maximum flexibility and customisation capabilities for the required solution.



## SIMPLE AND COMPACT LAYOUT

The C-NEXT range has been designed with a small footprint. By utilizing vertical space, it leaves customers more space for their application.



## COOLING PRECISION

Our experience in high-precision applications has led us to develop two kits, mainly created for laser applications, where a precision of  $\pm 1^{\circ}\text{C}$  or  $\pm 0.5^{\circ}\text{C}$  can be achieved.



## NON-FERROUS LIQUID CIRCUIT (STAINLESS STEEL AND BRASS)

All the liquid circuits of our industrial chillers are equipped as standard with pumps, unions and collection tanks in materials not subject to corrosion, primarily stainless steel and brass. This allows us to guarantee the maximum cleanliness and protection of your cooling circuits.

# TCW - TAL

## Industrial water chillers

TCW-TAL water chillers provide precision and reliability in a compact and modular design. With outputs from 800W up to 140 kW. The large range of accessories allows multiple chiller configurations.



# TCW08÷19 Minichiller

## Industrial water chillers

### COOLING CAPACITY

900-1100 - 1600-1900 - 2200-2550 W



### STRUCTURE

In powder-coated steel sheet, RAL 7035 textured finish. Easily removed panel

### COMPRESSOR

Hermetic reciprocating compressor, cooled by the refrigerant, complete with thermal cut-out.

### REFRIGERATION CIRCUIT

Complete with charging port, drier filter, expansion valve, high- and low-pressure safety pressure switch, R134a refrigerant.

### EVAPORATOR

Brazed stainless-steel plate model.

### AIR CONDENSER

Finned high-efficiency copper tube condensing coil, complete with safety grille.

### AXIAL FAN

Axial fan, complete with electrical protection and safety grille.

### LIQUID CIRCUIT

Liquid circuit composed entirely of non-ferrous material in contact with the liquid to prevent contamination. Standard liquid circuit with open reservoir and pump, protective flow switch, pressure gauge, regulation sensor. Peripheral electric pump with 4.5 bar available head. Plastic storage tank complete with drain valve and visual level indicator.

### ELECTRICAL PANEL

With main breaker, fused motor protection with LED visual fault indicator, voltage presence light.

### MANAGEMENT AND CONTROL

The TX110 control unit manages the chiller's operation, providing warnings including high/low temperature alarms and a general serious fault alarm, with the display indicating if this refers to the refrigeration or liquid circuit. An on-off contact allows the machine to be switched on remotely. Control disconnect switch for switching on the machine.

### PAINT/COATING

Standard colour: RAL 7035 textured.

### MAIN OPTIONS

- BA - Mechanical bypass valve protecting the pump
- BM - Manual bypass valve protecting the pump
- LE - Level indicator
- LTA - Operation at low ambient temperatures
- FP - Polyurethane air filter
- RU - Castors
- TD - Differential fluid temperature management (two sensors)
- BGC - Hot gas bypass for +/- 1 K temperature precision
- LS - Liquid circuit for laser application
- HIGH-pressure pump
- Satin AISI 304 stainless steel framework

### DIMENSIONS

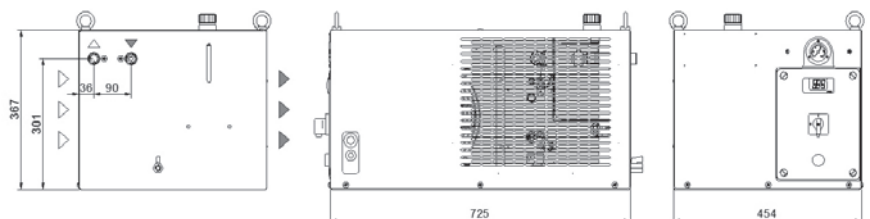

Model		TCW08		TCW12		TCW19	
		50Hz	60Hz	50Hz	60Hz	50Hz	60Hz
Rated Cooling Capacity*	W	900	1100	1600	1900	2200	2550
Ambient temperature operating limits	°C	+15 - +45					
Settable fluid temperature range	°C	+8 - +25					
Fluid type		Water					
Temperature precision	K	+/-2					
Refrigerant gas	HFC	R134a					
<b>Power supply</b>							
Supply voltage	V ph Hz	230V (+/-10%) 1ph 50/60Hz					
Secondary supply voltage	V	230					
Digital thermostat		TX110					
<b>Compressor</b>							
Compressor type		Reciprocating					
Quantity - Number of circuits	no.	1 - 1					
<b>Axial Fan</b>							
Fan type		Axial					
Quantity	no.	1		1		1	
Air flow rate	m <sup>3</sup> /h	1000		1000		1000	
Max. power draw	W	150	190	150	190	150	190
<b>Standard Pump</b>							
Pump type		Peripheral					
Nominal/max fluid flow rate	l/min	3.0 - 20.0		5.0 - 20.0		6.5 - 20.0	
Nominal available head	bar	5.4	7.6	4.6	6.7	4	6
<b>High-Pressure Pump (optional)</b>							
Pump type		Peripheral					
Quantity	no.	1		1		1	
Nominal available head	bar	6.5	8.4	6	7.9	5.8	7.6
<b>Storage tank capacity</b>							
Storage tank capacity	l	10					
IN/OUT liquid connections	mm	1/2"					
Net weight	kg	52		54		55	
Width - Depth - Height	mm	725 - 454 - 367					
Sound pressure level**	dB(A)	56		56		56	
<p>* Data relating to operation under the following conditions: intake/outlet temperature 20/15°C, water without glycol, ambient temperature 32°C. Cooling power refers to the evaporator unit.</p> <p>** Sound pressure level at 50Hz, measured in a free hemispherical field at a distance of 1 m from the machine and 1.5 metres from the ground, per ISO 3746.</p>							

Correction factors for calculating the cooling power													
Water outlet temperature	Fw	°C					8	10	15	20	25		
		factor					0.86	0.92	1	1.05	1.12		
Ambient Temperature	Fa	°C					15	20	25	32	35	40	45
		factor					1.16	1.1	1.05	1	0.97	0.91	0.84
Percentage glycol by weight	Fg	%	0	10	15	20	25	30	35	40			
		factor	1	0.99	0.98	0.97	0.96	0.94	0.92	0.89			
Cooling power = Nominal cooling power x Fw x Fa x Fg													

# TCW TCW31-41 Minichiller HP

## Industrial water chillers

COOLING CAPACITY

3000-3450 - 3900-4450 W



### STRUCTURE

In powder-coated steel sheet, RAL 7035 textured finish. Easily removed panel

### COMPRESSOR

Hermetic reciprocating compressor, cooled by the refrigerant, complete with thermal cut-out.

### REFRIGERATION CIRCUIT

Complete with charging port, drier filter, expansion valve, high- and low-pressure safety pressure switch, thermostatic valve.  
R134a refrigerant.

### EVAPORATOR

Brazed stainless-steel plate model.

### AIR CONDENSER

Finned high-efficiency copper tube condensing coil, complete with safety grille.

### AXIAL FAN

Axial fan, complete with electrical thermal protection and safety grille.

### LIQUID CIRCUIT

Liquid circuit composed entirely of non-ferrous material in contact with the liquid to prevent contamination. Standard liquid circuit with open reservoir and pump, protective flow switch, pressure gauge, regulation sensor. Peripheral electric pump with 4.5 bar available head. Plastic storage tank complete with drain valve and visual level indicator.

### ELECTRICAL PANEL

With main breaker, fused motor protection with LED visual fault indicator, voltage presence light.

### MANAGEMENT AND CONTROL

The TX110 control unit manages the chiller's operation, providing warnings including high/low temperature alarms and a general serious fault alarm, with the display indicating if this refers to the refrigeration or liquid circuit. An on-off contact allows the machine to be switched on remotely. Control disconnect switch for switching on the machine.

### PAINT/COATING

Standard colour: RAL 7035 textured.

### MAIN OPTIONS

- BA - Mechanical bypass valve protecting the pump
- BM - Manual bypass valve protecting the pump
- LE - Electrical level indicator
- LTA - Operation at low ambient temperatures
- FP - Polyurethane air filter
- RU - Castors
- TD - Differential fluid temperature management (two sensors)
- BGC - Hot gas bypass for +/- 1 K temperature precision
- HIGH-pressure pump
- Non-standard paint/coating
- Satin AISI 304 stainless steel framework

### DIMENSIONS

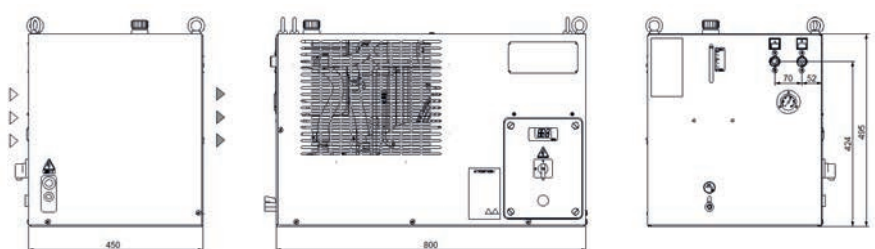

Model		TCW31		TCW41	
		50Hz	60Hz	50Hz	60Hz
Rated Cooling Capacity*	W	3000	3450	3900	4450
Ambient temperature operating limits	°C	+15 - +45			
Settable fluid temperature range	°C	+8 - +25			
Fluid type		Water			
Temperature precision	K	+/-2			
Refrigerant gas	HFC	R134a			
<b>Power supply</b>					
Supply voltage	V ph Hz	230V (+/-10%) 1ph 50/60Hz			
Secondary supply voltage	V	230			
Digital thermostat		TX110			
<b>Compressor</b>					
Compressor type		Reciprocating			
Quantity - Number of circuits	no.	1 - 1			
Max. power draw	kW	1.15	1.5	1.6	1.92
Max. current draw	A	6.1	8.1	7.2	8.4
<b>Axial Fan</b>					
Compressor type		Axial			
Quantity	no.	1		1	
Air flow rate	m³/h	2300	2650	2300	2650
Max. power draw	W	180	250	180	250
Max. current draw	A	0.81	1.1	0.81	1.1
<b>Standard Pump</b>					
Pump type		Peripheral			
Quantity	no.	1		1	
Nominal/max fluid flow rate	l/min	6.5 - 20		11 - 20	
Nominal available head	bar	4	6	2.8	4
Available power draw	kW	0.75	0.75	0.75	0.75
Max. current draw	A	2.8	3.7	2.8	3.7
<b>High-Pressure Pump (optional)</b>					
Pump type		Peripheral			
Quantity	no.	1		1	
Nominal available head	bar	5.8	7.6	4.9	6.6
Max. power draw	kW	1.29	1.29	1.29	1.29
Max. current draw	A	5	6	5	6
<b>Storage tank capacity</b>					
Storage tank capacity	l	10			
IN/OUT liquid connections	mm	1/2"			
Net weight (approximate)***	kg	74		75	
Width - Depth - Height	mm	800 - 450 - 495			
Sound pressure level**	dB(A)	57	60	57	60
IP rating	IP	44			
<p>* Data relating to operation under the following conditions: intake/outlet temperature 20/15°C, water without glycol, ambient temperature 32°C. Cooling power refers to the evaporator unit.</p> <p>** Sound pressure level at 50Hz, measured in a free hemispherical field at a distance of 1 m from the machine and 1.5 metres from the ground, per ISO 3746.</p> <p>*** Weight includes pallets and packaging (where provided for), with refrigerant charge, storage tank empty, axial fans.</p> <p>The electrical data refer to <math>\cos \phi = 0.8</math>.</p>					

Correction factors for calculating the cooling power													
Water outlet temperature	Fw	°C					8	10	15	20	25		
		factor					0.86	0.92	1	1.05	1.12		
Ambient Temperature	Fa	°C					15	20	25	32	35	40	45
		factor					1.16	1.1	1.05	1	0.97	0.91	0.84
Percentage glycol by weight	Fg	%	0	10	15	20	25	30	35	40			
		factor	1	0.99	0.98	0.97	0.96	0.94	0.92	0.89			
Cooling power = Nominal cooling power x Fw x Fa x Fg													

**Industrial water chillers****COOLING CAPACITY****2300-2700 - 3600-4200 W****STRUCTURE**

In powder-coated steel sheet, RAL 7035 textured finish. Easily removed panels

**COMPRESSOR**

Hermetic reciprocating compressor, cooled by the refrigerant, complete with thermal cut-out.

**REFRIGERATION CIRCUIT**

Complete with charging port, drier filter, expansion valve, high-pressure pressure switch, R134a refrigerant.

**EVAPORATOR**

Brazed stainless-steel plate model.

**AIR CONDENSER**

Microchannel condensing coil, complete with safety grille.

**AXIAL FAN**

Axial fan, complete with thermal cut-out and safety grille.

**LIQUID CIRCUIT**

Non-ferrous liquid circuit composed of peripheral electric pump, storage tank made of plastic material complete with integrated visual level indicator, 0-10 bar pressure gauge, protective flow switch, regulation sensor.

**ELECTRICAL PANEL**

With main disconnect switch, fused motor protection.

**MANAGEMENT AND CONTROL**

The TX110 control unit manages the chiller's operation, providing warnings including high/low temperature alarms and a general serious fault alarm, with the display indicating if this refers to the refrigeration or liquid circuit. An on-off contact allows the machine to be switched on remotely (pump included). Control disconnect switch for switching on the machine.

**PAINT/COATING**

Standard colour: RAL 7035 textured.

**MAIN OPTIONS**

- BA - Mechanical bypass valve protecting the pump
- LTA - Operation at low ambient temperatures
- FP - Polyurethane air filter
- RU - Castors
- TD - Differential fluid temperature management (two sensors)
- BGC - Hot gas bypass for +/- 1 K temperature precision
- BGP - Hot gas bypass for +/- 0.5 K temperature precision
- LS - Liquid circuit for laser application
- UL1 - Electrical panel and UL-certified components
- LTW - Water temperature range -10/+5 °C
- HIGH-pressure pump version "H" - 5 bar, version "R" - 7 bar.
- Outdoor installation options

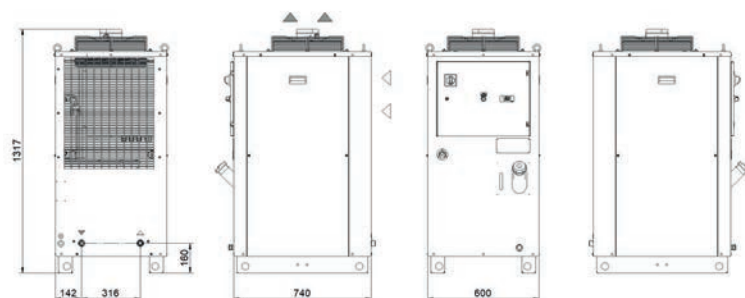
**DIMENSIONS**



Model		TAL24		TAL37	
		50Hz	60Hz	50Hz	60Hz
Rated Cooling Capacity*	W	2300	2700	3600	4200
Ambient temperature operating limits	°C	+15 - +45			
Settable fluid temperature range	°C	+8 - +25			
Fluid type		Water			
Temperature precision	K	+/-2			
Refrigerant gas	HFC	R134a			
<b>Power supply</b>					
Supply voltage	V ph Hz	230V (+/-10%) 1ph 50/60Hz			
Secondary supply voltage	V	230 V AC			
Digital thermostat		TX110			
<b>Compressor</b>					
Compressor type		Reciprocating			
Quantity - Number of circuits	no.	1 - 1			
Nominal power draw	kW	0.84	1.04	1.16	1.5
<b>Axial Fan</b>					
Fan type		Axial			
Quantity	no.	1			
Air flow rate	m³/h	1250 - 1650		1550 - 2050	
<b>Centrifugal Fan (optional)</b>					
Fan type		Centrifugal			
Quantity	no.	1			
Air flow rate	m³/h	2100 - 2400		2100 - 2400	
Available head	Pa	250			
<b>Standard Pump</b>					
Pump type		Peripheral			
Quantity	no.	1			
Nominal/max fluid flow rate	l/min	7 - 18		10 - 18	
Nominal available head	bar	3.8	5.8	3.1	4.5
<b>High-Pressure Pump (optional)</b>					
Pump type		Peripheral			
Quantity	no.	1			
Nominal available head	bar	5.6	7.5	5	6.8
Storage tank capacity	l	50			
IN/OUT liquid connections	inch	3/4"			
Net weight (approximate)***	kg	151		153	
Width - Depth - Height	mm	600 - 740 - 1317			
Sound pressure level**	dB(A)	57	60	57	60

\* Data relates to operation under the following conditions: inlet/outlet temp. 20/15°C, water without glycol, ambient temperature 32°C.

\*\* Sound pressure level, measured in a free parallelepiped field at a distance of 1 m, per ISO 3746.

\*\*\* Weight includes pallets and packaging (where provided for), with refrigerant charge, storage tank empty, axial fans.

The electrical data refer to  $\cos \phi = 0.8$ .

Correction factors for calculating the cooling power													
Water outlet temperature	Fw	°C					8	10	15	20	25		
		factor					0.69	0.77	1	1.22	1.44		
Ambient Temperature	Fa	°C					15	20	25	32	35	40	45
		factor					1.26	1.2	1.11	1	0.95	0.87	0.80
Percentage glycol by weight	Fg	%	0	10	15	20	25	30	35	40			
		factor	1	0.96	0.95	0.94	0.93	0.91	0.90	0.88			
Cooling power = Nominal cooling power x Fw x Fa x Fg													

## Industrial water chillers

### COOLING CAPACITY

2900 - 3600 - 4550 - 6000 - 8100 - 9550 - 10900 W



### STRUCTURE

In powder-coated steel sheet, RAL 7035 textured finish. Easily removed panels

### COMPRESSOR

Hermetic Reciprocating or Scroll compressor, cooled by the refrigerant, complete with thermal cut-out.

### REFRIGERATION CIRCUIT

Complete with charging port, drier filter, expansion or thermostatic valve, high-pressure pressure switch, R134a refrigerant.

### EVAPORATOR

Brazed stainless-steel plate model.

### AIR CONDENSER

Microchannel condensing coil, complete with safety grille.

### AXIAL FAN

Axial fan, complete with thermal cut-out and safety grille.

### LIQUID CIRCUIT

Non-ferrous liquid circuit composed of centrifugal electric pump, storage tank made of plastic material complete with integrated visual level indicator, 0-10 bar pressure gauge, protective flow switch, regulation sensor.

### ELECTRICAL PANEL

With main disconnect switch, relay motor protection, phase sequence relays.

### MANAGEMENT AND CONTROL

The TX110 control unit manages the chiller's operation, providing warnings including high/low temperature alarms and a general serious fault alarm, with the display indicating if this refers to the refrigeration or liquid circuit. An on-off contact allows the machine to be switched on remotely (pump included). Control disconnect switch for switching on the machine.

### PAINT/COATING

Standard colour: RAL 7035 textured.

### MAIN OPTIONS

- BA - Mechanical bypass valve protecting the pump
- LTA - Operation at low ambient temperatures
- FP - Polyurethane air filter
- RU - Castors
- TD - Differential fluid temperature management (two sensors)
- BGC - Hot gas bypass for +/- 1 K temperature precision
- BGP - Hot gas bypass for +/- 0.5 K temperature precision
- LS - Liquid circuit for laser application
- UL1 - Electrical panel and UL-certified components
- LTW - Water temperature range -10/+5 °C
- HIGH-pressure pump version "H" - 5 bar, version "R" - 7 bar.
- Outdoor installation options

### DIMENSIONS

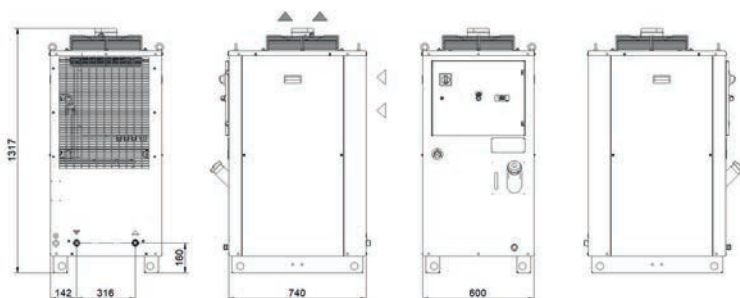

Model		TAL29	TAL37	TAL46	TAL57	TAL76	TAL93	TALAO	
<b>Rated Cooling Capacity*</b>	W	2900	3600	4550	6000	8100	9550	10900	
Ambient temperature operating limits	°C	+15 - +45							
Settable fluid temperature range	°C	+8 - +25							
Fluid type		Water							
Temperature precision	K	+/-2							
Refrigerant gas	HFC	R134a							
<b>Power supply</b>									
Supply voltage	V ph Hz	400V (+/-10%) 3ph 50Hz							
Secondary supply voltage	V	230 V AC							
Digital thermostat		TX110							
<b>Compressor</b>									
Compressor type		Reciprocating				Scroll			
Quantity - Number of circuits	no.	1 - 1							
Nominal power draw	kW	0.78	1.16	1.42	2.42	2.21	2.60	2.73	
<b>Axial Fan</b>									
Fan type		Axial							
Quantity	no.	1							
Air flow rate	m <sup>3</sup> /h	1550	1550	1800	1800	3150	3350	4400	
<b>Centrifugal Fan (optional)</b>									
Fan type		Centrifugal							
Quantity	no.	1							
Air flow rate	m <sup>3</sup> /h	2100 - 2400	2100 - 2400	2100 - 2400	2100 - 2400	2100 - 2400	2100 - 2400	2100 - 2400	
Available head	Pa	250							
<b>Standard Pump</b>									
Pump type		Centrifugal							
Quantity	no.	1							
Nominal/max fluid flow rate	l/min	8 - 40	10 - 40	12.5 - 40	16 - 40	21 - 70	26 - 70	31.5 - 70	
Nominal available head	bar	3	2.9	2.8	2.7	3.1	3	2.8	
<b>High-Pressure Pump (optional)</b>									
Pump type		Centrifugal							
Quantity	no.	1							
Nominal available head	bar	5.1	4.9	4.8	4.6	5.5	5.3	5.1	
Storage tank capacity	l	50							
IN/OUT liquid connections	inch	3/4"							
Net weight (approximate)***	kg	151	153	155	160	165	170	175	
Width - Depth - Height	mm	600 - 740 - 1317							
Sound pressure level**	dB(A)	57	57	57	57	57	57	57	

\* Data relates to operation under the following conditions: inlet/outlet temp. 20/15°C, water without glycol, ambient temperature 32°C.

\*\* Sound pressure level, measured in a free parallelepiped field at a distance of 1 m, per ISO 3746.

\*\*\* Weight includes pallets and packaging (where provided for), with refrigerant charge, storage tank empty, axial fans.

The electrical data refer to cos φ = 0.8.

Correction factors for calculating the cooling power													
<b>Water outlet temperature</b>	<b>Fw</b>	°C					<b>8</b>	<b>10</b>	<b>15</b>	<b>20</b>	<b>25</b>		
		factor					0.69	0.77	1	1.22	1.44		
<b>Ambient Temperature</b>	<b>Fa</b>	°C					<b>15</b>	<b>20</b>	<b>25</b>	<b>32</b>	<b>35</b>	<b>40</b>	<b>45</b>
		factor					1.26	1.2	1.11	1	0.95	0.87	0.80
<b>Percentage glycol by weight</b>	<b>Fg</b>	%	<b>0</b>	<b>10</b>	<b>15</b>	<b>20</b>	<b>25</b>	<b>30</b>	<b>35</b>	<b>40</b>			
		factor	1	0.96	0.95	0.94	0.93	0.91	0.90	0.88			
Cooling power = Nominal cooling power x Fw x Fa x Fg													

## Industrial water chillers

**COOLING CAPACITY**
**11400 - 12400 - 17800 - 20100 W**

### STRUCTURE

In powder-coated steel sheet, RAL 7035 textured finish. Easily removed panels

### COMPRESSOR

Hermetic scroll compressor, cooled by the refrigerant, complete with thermal cut-out.

### REFRIGERATION CIRCUIT

Complete with charging port, liquid receiver, drier filter, thermostatic valve, high- and low-pressure pressure switch, R410A refrigerant.

### EVAPORATOR

Brazed stainless-steel plate model.

### AIR CONDENSER

Microchannel condensing coil, complete with safety grille.

### AXIAL FAN

Axial fan, complete with thermal cut-out and safety grille.

### LIQUID CIRCUIT

Non-ferrous liquid circuit composed of stainless steel centrifugal electric pump, storage tank made of plastic material complete with integrated visual level indicator, electrical level indicator, 0-10 bar pressure gauge, differential pressure switch protecting the water flow, regulation sensor.

### ELECTRICAL PANEL

With main disconnect switch, relay motor protection, phase sequence relays.

### MANAGEMENT AND CONTROL

The TX200 control unit manages the operation of the chiller and provides complete operator alarm diagnostics. An on-off contact allows the machine to be switched on remotely. Illuminated control selector. Possibility of remote display for machine regulation.

### PAINT/COATING

Standard colour: RAL 7035 textured.

### MAIN OPTIONS

- BA - Mechanical bypass valve protecting the pump
- FL - Flow switch with alarm contact
- FP - Polyurethane air filter
- RU - Castors
- TD - Differential fluid temperature management (two sensors)
- BGC - Hot gas bypass for +/- 1 K temperature precision
- LS - Liquid circuit for laser application
- HP/HS - Harting-type connector
- HIGH-pressure pump version "H" - 5 bar, version "R" - 7 bar.
- Outdoor installation options

### DIMENSIONS

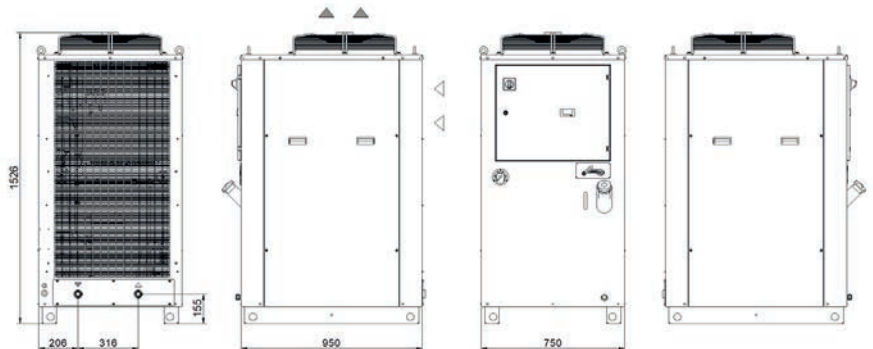

Model		TALA1	TALA3	TALA5	TALA8
<b>Rated Cooling Capacity*</b>	W	11400	12400	17800	20100
Ambient temperature operating limits	°C	+15 - +45			
Settable fluid temperature range	°C	+8 - +25			
Fluid type		Water			
Temperature precision	K	+/-2			
Refrigerant gas	HFC	R410A			
<b>Power supply</b>					
Supply voltage	V ph Hz	400V (+/-10%) 3ph 50Hz			
Secondary supply voltage	V	24 V AC			
Digital thermostat		TX200			
<b>Compressor</b>					
Compressor type		Scroll			
Quantity - Number of circuits	no.	1 - 1			
Nominal power draw	kW	3.03	3.12	4.08	4.91
<b>Axial Fan</b>					
Fan type		Axial			
Quantity	no.	1			
Air flow rate	m³/h	6500	6500	6500	6500
<b>Centrifugal Fan (optional)</b>					
Fan type		Centrifugal			
Quantity	no.	1			
Air flow rate	m³/h	6500	6500	6500	6500
Available head	Pa	250			
<b>Standard Pump</b>					
Pump type		Centrifugal			
Quantity	no.	1			
Nominal/max fluid flow rate	l/min	31 - 70	35 - 70	50 - 70	58 - 70
Nominal available head	bar	3.7	3.5	2.8	2.5
<b>High-Pressure Pump (optional)</b>					
Pump type		Centrifugal			
Quantity	no.	1			
Nominal available head	bar	5.2	5	5	4.2
Storage tank capacity	l	130			
IN/OUT liquid connections	inch	1"			
Net weight (approximate)***	kg	200	200	235	235
Width - Depth - Height	mm	750 - 950 - 1526			
Sound pressure level**	dB(A)	67	67	67	67

\* Data relates to operation under the following conditions: inlet/outlet temp. 20/15°C, water without glycol, ambient temperature 32°C.

\*\* Sound pressure level, measured in a free parallelepiped field at a distance of 1 m, per ISO 3746.

\*\*\* Weight includes pallets and packaging (where provided for), with refrigerant charge, storage tank empty, axial fans.

The electrical data refer to cos φ = 0.8.

Correction factors for calculating the cooling power													
<b>Water outlet temperature</b>	<b>Fw</b>	°C					<b>8</b>	<b>10</b>	<b>15</b>	<b>20</b>	<b>25</b>		
		factor					0.76	0.82	1	1.22	1.43		
<b>Ambient Temperature</b>	<b>Fa</b>	°C					<b>15</b>	<b>20</b>	<b>25</b>	<b>32</b>	<b>35</b>	<b>40</b>	<b>45</b>
		factor					1.26	1.2	1.12	1	0.95	0.87	0.80
<b>Percentage glycol by weight</b>	<b>Fg</b>	%	<b>0</b>	<b>10</b>	<b>15</b>	<b>20</b>	<b>25</b>	<b>30</b>	<b>35</b>	<b>40</b>			
		factor	1	0.96	0.95	0.94	0.93	0.91	0.90	0.88			
Cooling power = Nominal cooling power x Fw x Fa x Fg													

## Industrial water chillers

**COOLING CAPACITY**
**24800 - 29000 - 35800 W**

material complete with integrated visual level indicator, electrical level indicator, 0-10 bar pressure gauge, differential pressure switch protecting the water flow, automatic by-pass and regulation sensor.

### ELECTRICAL PANEL

With main disconnect switch, relay motor protection, phase sequence relays.

### MANAGEMENT AND CONTROL

The TX200 control unit manages the operation of the chiller and provides complete operator alarm diagnostics. An on-off contact allows the machine to be switched on remotely. Illuminated control selector. Possibility of remote display for machine regulation.

### STRUCTURE

In powder-coated steel sheet, RAL 7035 textured finish. Easily removed panels

### COMPRESSOR

Hermetic scroll compressor, cooled by the refrigerant, complete with thermal cut-out.

### REFRIGERATION CIRCUIT

Complete with charging port, liquid receiver, drier filter, thermostatic valve, high- and low-pressure pressure switch, R410A refrigerant.

### EVAPORATOR

Brazed stainless-steel plate model.

### AIR CONDENSER

Microchannel condensing coil, complete with safety grille.

### AXIAL FAN

Axial fan, complete with thermal cut-out and safety grille.

### LIQUID CIRCUIT

Non-ferrous liquid circuit composed of stainless steel centrifugal electric pump, storage tank made of plastic

### PAINT/COATING

Standard colour: RAL 7035 textured.

### MAIN OPTIONS

- FL - Flow switch with alarm contact
- FP - Polyurethane air filter
- RU - Castors
- TD - Differential fluid temperature management (two sensors)
- BGC - Hot gas bypass for +/- 1 K temperature precision
- LS - Liquid circuit for laser application
- HP/HS - Harting-type connector
- HIGH-pressure pump version "H" - 5 bar, version "R" - 7 bar.
- Outdoor installation options

### DIMENSIONS

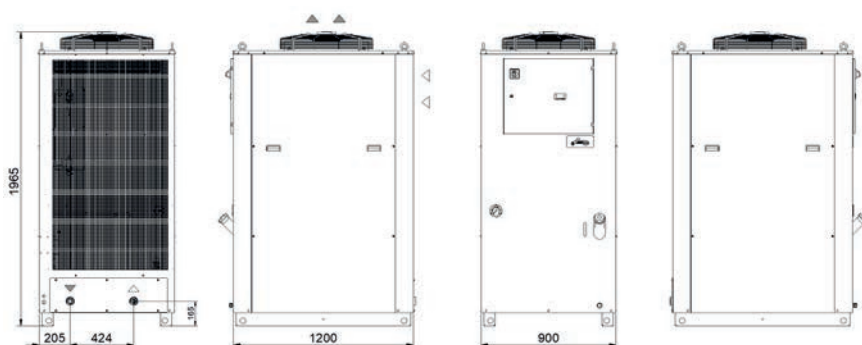

Model		TALB5	TALB9	TALC5
<b>Rated Cooling Capacity*</b>	W	24800	29000	35800
Ambient temperature operating limits	°C	+15 - +45		
Settable fluid temperature range	°C	+8 - +25		
Fluid type		Water		
Temperature precision	K	+/-2		
Refrigerant gas	HFC	R410A		
<b>Power supply</b>				
Supply voltage	V ph Hz	400V (+/-10%) 3ph 50Hz		
Secondary supply voltage	V	24 V AC		
Digital thermostat		TX200		
<b>Compressor</b>				
Compressor type		Scroll		
Quantity - Number of circuits	no.	1 - 1		
Nominal power draw	kW	6.4	7.4	8.6
<b>Axial Fan</b>				
Fan type		Axial		
Quantity	no.	1		
Air flow rate	m³/h	8300	9700	11500
<b>Centrifugal Fan (optional)</b>				
Fan type		Centrifugal		
Quantity	no.	1		
Air flow rate	m³/h	8300	9700	11500
Available head	Pa	370	180	100
<b>Standard Pump</b>				
Pump type		Centrifugal		
Quantity	no.	1		
Nominal/max fluid flow rate	l/min	79 - 150	92 - 150	100 - 150
Nominal available head	bar	3.5	3.2	3.0
<b>High-Pressure Pump (optional)</b>				
Pump type		Centrifugal		
Quantity	no.	1		
Nominal available head	bar	5.4	5.1	4.9
Storage tank capacity	l	130		
IN/OUT liquid connections	inch	1 1/2"		
Net weight (approximate)***	kg	260	260	260
Width - Depth - Height	mm	900 - 1200 - 1965		
Sound pressure level**	dB(A)	67	67	67

\* Data relates to operation under the following conditions: inlet/outlet temp. 20/15°C, water without glycol, ambient temperature 32°C.

\*\* Sound pressure level, measured in a free parallelepiped field at a distance of 1 m, per ISO 3746.

\*\*\* Weight includes pallets and packaging (where provided for), with refrigerant charge, storage tank empty, axial fans.

The electrical data refer to  $\cos \phi = 0.8$ .

#### Correction factors for calculating the cooling power

Water outlet temperature	Fw	°C										
		factor					8	10	15	20	25	
Ambient Temperature	Fa	°C										
		factor					15	20	25	32	35	40
Percentage glycol by weight	Fg	%	0	10	15	20	25	30	35	40		
		factor	1	0.96	0.95	0.94	0.93	0.91	0.90	0.88		

$$\text{Cooling power} = \text{Nominal cooling power} \times F_w \times F_a \times F_g$$

## Industrial water chillers

**COOLING CAPACITY**
**40000 - 47000 - 55000 - 67000 W**

pump, storage tank made of plastic material complete with drain valve, electrical level indicator, 0-10 bar pressure gauge, differential pressure switch protecting the water flow, automatic by-pass and regulation sensor.

### ELECTRICAL PANEL

With main disconnect switch, relay motor protection, phase sequence relays.

### MANAGEMENT AND CONTROL

The TX350C control unit manages the operation of the chiller and provides complete operator alarm diagnostics. An on-off contact allows the machine to be switched on remotely. Illuminated control selector. RS485 connection. Possibility of remote display for machine regulation.

### STRUCTURE

In powder-coated steel sheet, RAL 7035 textured finish. Easily removed panels

### COMPRESSOR

Hermetic scroll compressor, cooled by the refrigerant, complete with thermal cut-out.

### REFRIGERATION CIRCUIT

Complete with charging port, liquid receiver, drier filter, thermostatic valve, high- and low-pressure pressure switch, R410A refrigerant. Optional 2-step cooling power regulation (standard on TALF8).

### EVAPORATOR

Brazed stainless-steel plate model.

### AIR CONDENSER

Microchannel condensing coil, complete with safety grille.

### AXIAL FAN

Axial fan, complete with thermal cut-out and safety grille.

### LIQUID CIRCUIT

Non-ferrous liquid circuit composed of stainless steel centrifugal electric

### PAINT/COATING

Standard colour: RAL 7035 textured.

### MAIN OPTIONS

- FL - Flow switch with alarm contact
- HR - Fluid heating element
- OM - Unit built for outdoor operation down to -10 °C ambient temp.
- OML - Unit built for outdoor operation down to -20 °C ambient temp.
- FP - Polyurethane air filter
- TD - Differential fluid temperature management (two sensors)
- BGC - Hot gas bypass for +/- 1 K temperature precision
- LS - Liquid circuit for laser application
- HIGH-pressure pump version "H" - 5 bar

### DIMENSIONS

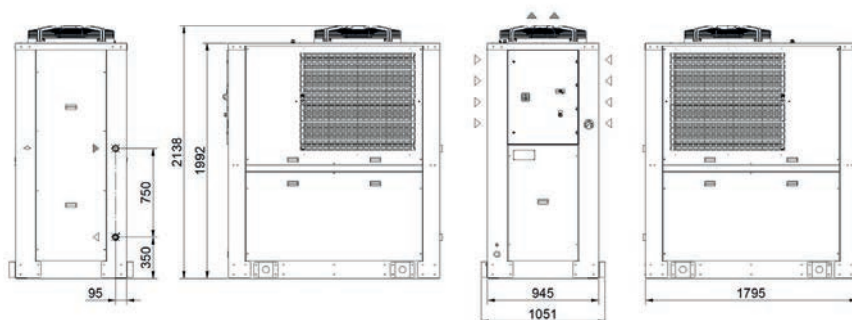



Model		TALD0	TALD9	TALE6	TALF8
Rated Cooling Capacity*	W	40000	47000	55000	67000
Ambient temperature operating limits	°C	+15 - +45			
Settable fluid temperature range	°C	+8 - +25			
Fluid type		Water			
Temperature precision	K	+/-2			
Refrigerant gas	HFC	R410A			
<b>Power supply</b>					
Supply voltage	V ph Hz	400V (+/-10%) 3ph 50Hz			
Secondary supply voltage	V	24 V AC			
Digital thermostat		TX350C			
<b>Compressor</b>					
Compressor type		Scroll			
Quantity - Number of circuits	no.	1 - 1			2 - 1
Max. power draw	kW	9.4	10.4	12.1	25.0
<b>Axial Fan</b>					
Fan type		Axial			
Quantity	no.	1	1	1	1
Air flow rate	m <sup>3</sup> /h	12600	14400	16000	24000
<b>Centrifugal Fan (optional)</b>					
Fan type		Centrifugal			
Quantity	no.	1	1	1	1
Air flow rate	m <sup>3</sup> /h	12600	14400	16000	24000
Available head	Pa	570	350	200	150
<b>Standard Pump</b>					
Pump type		Centrifugal			
Quantity	no.	1	1	1	1
Nominal/max fluid flow rate	l/min	115 - 230	135 - 230	158 - 230	200 - 230
Nominal available head	bar	3.8	3.6	4.6	3.8
<b>High Pressure Pump</b>					
Pump type		Centrifugal			
Quantity	no.	1	1	1	1
Nominal available head	bar	6.5	6.2	6.7	5.7
<b>Storage tank capacity</b>					
Storage tank capacity	l	200			
IN/OUT liquid connections	inch	1 1/2"			
Net weight (approximate)***	kg	580	600	600	600
Width - Depth - Height	mm	945 - 1795 - 2138			
Sound pressure level**	dB(A)	75	75	75	78
<p>* Data relates to operation under the following conditions: inlet/outlet temp. 20/15°C, water without glycol, ambient temperature 32°C.</p> <p>** Sound pressure level, measured in a free parallelepiped field at a distance of 1 m, per ISO 3746.</p> <p>*** Weight includes pallets and packaging (where provided for), with refrigerant charge, storage tank empty, axial fans.</p> <p>The electrical data refer to cos φ = 0.8.</p>					

Correction factors for calculating the cooling power													
Water outlet temperature	Fw	°C					8	10	15	20	25		
		factor					0.77	0.83	1	1.20	1.41		
Ambient Temperature	Fa	°C					15	20	25	32	35	40	45
		factor					1.27	1.2	1.13	1	0.95	0.86	0.80
Percentage glycol by weight	Fg	%	0	10	15	20	25	30	35	40			
		factor	1	0.96	0.95	0.94	0.93	0.91	0.90	0.88			
Cooling power = Nominal cooling power x Fw x Fa x Fg													

## Industrial water chillers

**COOLING CAPACITY**
**80000 - 94000 - 110000 - 134000 W**

### STRUCTURE

In powder-coated steel sheet, RAL 7035 textured finish. Easily removed panels

### COMPRESSOR

Hermetic scroll compressor, cooled by the refrigerant, complete with thermal cut-out.

### REFRIGERATION CIRCUIT

Complete with charging port, liquid receiver, drier filter, thermostatic valve, high- and low-pressure pressure switch, R410A refrigerant. Stepped cooling power regulation - 2 steps standard / 4 steps optional (standard on TALO6).

### EVAPORATOR

Brazed stainless-steel plate model.

### AIR CONDENSER

Microchannel condensing coil, complete with safety grille.

### AXIAL FAN

Axial fan, complete with thermal cut-out and safety grille.

### LIQUID CIRCUIT

Non-ferrous liquid circuit composed

of stainless steel centrifugal electric pump, storage tank made of plastic material complete with drain valve, electrical level indicator, 0-10 bar pressure gauge, differential pressure switch protecting the water flow, automatic by-pass and regulation sensor.

### ELECTRICAL PANEL

With main disconnect switch, relay motor protection, phase sequence relays.

### MANAGEMENT AND CONTROL

The TX350C control unit manages the operation of the chiller and provides complete operator alarm diagnostics. An on-off contact allows the machine to be switched on remotely. Illuminated control selector. RS485 connection. Possibility of remote display for machine regulation.

### PAINT/COATING

Standard colour: RAL 7035 textured.

### MAIN OPTIONS

FL - Flow switch with alarm contact

HR - Fluid heating element

OM - Unit built for outdoor operation down to -10 °C ambient temp.

OML - Unit built for outdoor operation down to -20 °C ambient temp.

FP - Polyurethane air filter

TD - Differential fluid temperature management (two sensors)

BGC - Hot gas bypass for +/- 1 K temperature precision

LS - Liquid circuit for laser application

- HIGH-pressure pump version "H" - 5 bar

### DIMENSIONS

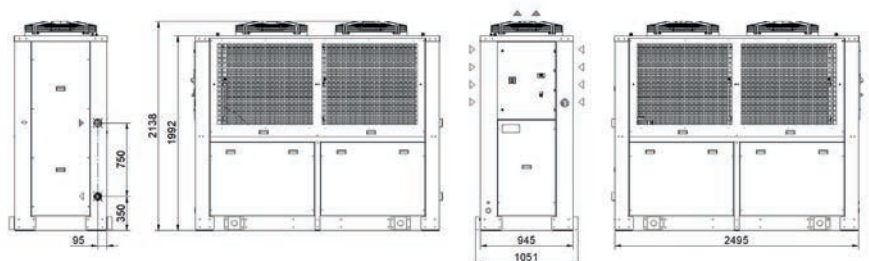

Model		TALG9	TALI4	TALM0	TALO6
<b>Rated Cooling Capacity*</b>	W	80000	94000	110000	134000
Ambient temperature operating limits	°C	+15 - +45			
Settable fluid temperature range	°C	+8 - +25			
Fluid type		Water			
Temperature precision	K	+/-2			
Refrigerant gas	HFC	R410A			
<b>Power supply</b>					
Supply voltage	V ph Hz	400V (+/-10%) 3ph 50Hz			
Secondary supply voltage	V	24 V AC			
Digital thermostat		TX350C			
<b>Compressor</b>					
Compressor type		Scroll			
Quantity - Number of circuits	no.	2 - 2			4 - 2
Max. power draw	kW	18.8	20.8	24.2	50.0
<b>Axial Fan</b>					
Fan type		Axial			
Quantity	no.	2	2	2	2
Air flow rate	m³/h	25200	28800	32000	48000
<b>Centrifugal Fan (optional)</b>					
Fan type		Centrifugal			
Quantity	no.	2	2	2	2
Air flow rate	m³/h	25200	28800	32000	48000
Available head	Pa	570	350	200	150
<b>Standard Pump</b>					
Pump type		Centrifugal			
Quantity	no.	1	1	1	1
Nominal/max fluid flow rate	l/min	230 - 400	270 - 400	316 - 400	400 - 400
Nominal available head	bar	4.7	4.4	4	3.6
<b>High Pressure Pump</b>					
Pump type		Centrifugal			
Quantity	no.	1	1	1	1
Nominal available head	bar	6	5.5	5	5
<b>Storage tank capacity</b>					
Storage tank capacity	l	300			
IN/OUT liquid connections	inch	2"1/2			
Net weight (approximate)***	kg	730	750	750	750
Width - Depth - Height	mm	945 - 2495 - 2139			
Sound pressure level**	dB(A)	75	75	75	78
<p>* Data relates to operation under the following conditions: inlet/outlet temp. 20/15°C, water without glycol, ambient temperature 32°C.</p> <p>** Sound pressure level, measured in a free parallelepiped field at a distance of 1 m, per ISO 3746.</p> <p>*** Weight includes pallets and packaging (where provided for), with refrigerant charge, storage tank empty, axial fans.</p> <p>The electrical data refer to cos φ = 0.8.</p>					

Correction factors for calculating the cooling power													
<b>Water outlet temperature</b>	<b>Fw</b>	°C					<b>8</b>	<b>10</b>	<b>15</b>	<b>20</b>	<b>25</b>		
		factor					0.77	0.83	1	1.20	1.41		
<b>Ambient Temperature</b>	<b>Fa</b>	°C					<b>15</b>	<b>20</b>	<b>25</b>	<b>32</b>	<b>35</b>	<b>40</b>	<b>45</b>
		factor					1.27	1.2	1.13	1	0.95	0.86	0.80
<b>Percentage glycol by weight</b>	<b>Fg</b>	%	<b>0</b>	<b>10</b>	<b>15</b>	<b>20</b>	<b>25</b>	<b>30</b>	<b>35</b>	<b>40</b>			
		factor	1	0.96	0.95	0.94	0.93	0.91	0.90	0.88			
Cooling power = Nominal cooling power x Fw x Fa x Fg													

# TCO - TAO

## Industrial oil chillers

TCO-TAO oil chillers provide precision and reliability in a compact and modular design. With outputs from 800W up to 67 kW.



# TCO08÷19 Minichiller

## Industrial oil chillers

### COOLING CAPACITY

900-1100 - 1600-1900 - 2200-2550 W



### STRUCTURE

In powder-coated steel sheet, RAL 7035 textured finish. Easily removed panels

### COMPRESSOR

Hermetic reciprocating compressor, cooled by the refrigerant, complete with thermal cut-out.

### REFRIGERATION CIRCUIT

Complete with charging port, drier filter, expansion valve, high- and low-pressure safety pressure switch, R134a refrigerant.

### EVAPORATOR

Brazed stainless-steel plate model.

### AIR CONDENSER

Finned high-efficiency copper tube condensing coil, complete with safety grille.

### AXIAL FAN

Axial fan, complete with electrical protection and safety grille.

### HYDRAULIC CIRCUIT

Hydraulic circuit with gear pump without tank, with maximum available pressure 20 bar, 0-25 bar pressure gauge, regulation temperature sensor. Hydraulic safety with safety low- and high-pressure pressure switch.

### ELECTRICAL PANEL

With main breaker, fused motor protection with LED visual fault indicator, voltage presence light.

### MANAGEMENT AND CONTROL

The TX110 control unit manages the chiller's operation, providing warnings including high/low temperature alarms and a general serious fault alarm, with the display indicating if this refers to the refrigeration or hydraulic circuit. An on-off contact allows the machine to be switched on remotely. Control disconnect switch for switching on the machine.

### PAINT/COATING

Standard colour: RAL 7035 textured.

### MAIN OPTIONS

- LTA - Operation at low ambient temperatures
- FP - Polyurethane air filter
- RU - Castors
- TD - Differential fluid temperature management (two sensors)
- BGC - Hot gas bypass for +/- 1 K temperature precision
- FL - Customer flow switch
- Non-standard paint/coating
- Satin AISI 304 stainless steel framework

### DIMENSIONS

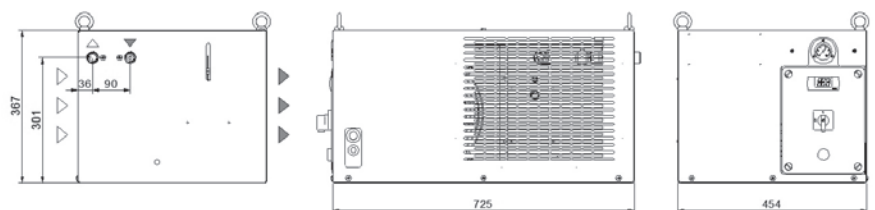

Model		TCO08		TCO12		TCO19	
		50Hz	60Hz	50Hz	60Hz	50Hz	60Hz
<b>Rated Cooling Capacity*</b>	W	900	1100	1600	1900	2200	2550
Ambient temperature operating limits	°C	+15 - +45					
Settable oil temperature range	°C	+25 - +40					
Fluid type		ISO VG 32					
Temperature precision	K	+/-2					
Refrigerant gas	HFC	R134a					
<b>Power supply</b>							
Supply voltage	V ph Hz	230V (+/-10%) 1ph 50/60Hz					
Secondary supply voltage	V AC	230					
Digital thermostat		TX110					
<b>Compressor</b>							
Compressor type		Reciprocating					
Quantity - Number of circuits	no.	1 - 1					
Max. power draw	kW	0.5	0.6	0.7	1.1	1.0	1.15
Max. current draw	A	2.8	3.1	4.1	4.3	6.0	6.5
<b>Axial Fan</b>							
Fan type		Axial					
Quantity	no.	1		1		1	
Air flow rate	m³/h	1000		1000		1000	
Max. power draw	W	150	190	150	190	150	190
Max. current draw	A	0.66	0.85	0.66	0.85	0.66	0.85
<b>Standard Pump</b>							
Pump type		Gear pump					
Quantity	no.	1		1		1	
Nominal fluid flow rate	l/min	10		10		10	
Nominal available head	bar	20		20		20	
Max. power draw	kW	0.55		0.55		0.55	
Max. current draw	A	4.0	4.2	4.0	4.2	4.0	4.2
Storage tank capacity (optional)	l	10					
IN/OUT liquid connections	inch	1/2"					
Net weight (approximate)***	kg	59		61		63	
Width - Depth - Height	mm	725 - 454 - 367					
Sound pressure level**	dB(A)	56		56		56	
IP rating	IP	44					

\* Data relating to operation under the following conditions: intake/outlet temperature 40/30°C, ISO VG 32 oil, ambient temperature 32°C. Cooling power refers to the evaporator unit.

\*\* Sound pressure level at 50Hz, measured in a free hemispherical field at a distance of 1 m from the machine and 1.5 metres from the ground, per ISO 3746.

\*\*\* Weight includes pallets and packaging (where provided for), with refrigerant charge, without storage tank and axial fans.

The electrical data refer to  $\cos \phi = 0.8$ .

Correction factors for calculating the cooling power												
<b>Oil outlet temperature</b>	<b>Fo</b>	°C	<b>20</b>	<b>25</b>	<b>30</b>	<b>35</b>						
		factor	0.82	0.92	1	1.05						
<b>Ambient Temperature</b>	<b>Fa</b>	°C				<b>15</b>	<b>20</b>	<b>25</b>	<b>32</b>	<b>35</b>	<b>40</b>	<b>45</b>
		factor				1.16	1.1	1.05	1	0.97	0.91	0.84
<b>Oil type</b>	<b>Ft</b>	type	<b>ISO VG 10</b>		<b>ISO VG 22</b>		<b>ISO VG 32</b>		<b>ISO VG 46</b>		<b>ISO VG 68</b>	
		factor	1.15		1.1		1		0.9		0.82	
Cooling power = Nominal cooling power x Fo x Fa x Ft												

# TCO31-41 Minichiller HP

## Industrial oil chillers

### COOLING CAPACITY

3000-3450 - 3900-4450 W



### STRUCTURE

In powder-coated steel sheet, RAL 7035 textured finish. Easily removed panels

### COMPRESSOR

Hermetic reciprocating compressor, cooled by the refrigerant, complete with thermal cut-out.

### REFRIGERATION CIRCUIT

Complete with charging port, drier filter, expansion valve, high- and low-pressure safety pressure switch, R134a refrigerant.

### EVAPORATOR

Brazed stainless-steel plate model.

### AIR CONDENSER

Finned high-efficiency copper tube condensing coil, complete with safety grille.

### AXIAL FAN

Axial fan, complete with electrical protection and safety grille.

### HYDRAULIC CIRCUIT

Hydraulic circuit with gear pump without tank, with maximum available pressure 20 bar, 0-25 bar pressure gauge, regulation temperature sensor. Hydraulic safety with safety low- and high-pressure pressure switch.

### ELECTRICAL PANEL

With main breaker, fused motor protection with LED visual fault indicator, voltage presence light.

### MANAGEMENT AND CONTROL

The TX110 control unit manages the chiller's operation, providing warnings including high/low temperature alarms and a general serious fault alarm, with the display indicating if this refers to the refrigeration or hydraulic circuit. An on-off contact allows the machine to be switched on remotely. Control disconnect switch for switching on the machine.

### PAINT/COATING

Standard colour: RAL 7035 textured.

### MAIN OPTIONS

- LTA - Operation at low ambient temperatures
- FP - Polyurethane air filter
- RU - Castors
- TD - Differential fluid temperature management (two sensors)
- BGC - Hot gas bypass for +/- 1 K temperature precision
- FL - Customer flow switch
- Non-standard paint/coating
- Satin AISI 304 stainless steel framework

### DIMENSIONS

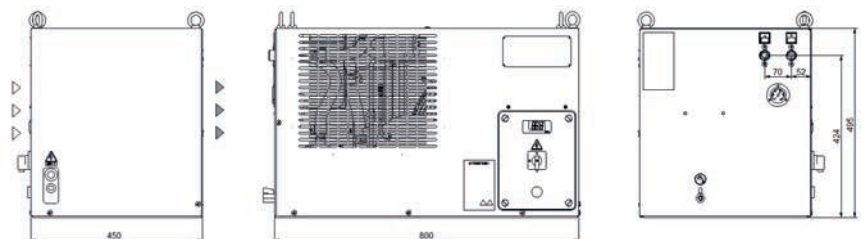



Model		TCO31		TCO41	
		50Hz	60Hz	50Hz	60Hz
<b>Rated Cooling Capacity*</b>	W	3000	3450	3900	4450
Ambient temperature operating limits	°C	+15 - +45			
Settable oil temperature range	°C	+25 - +40			
Fluid type		ISO VG 32			
Temperature precision	K	+/-2			
Refrigerant gas	HFC	R134a			
<b>Power supply</b>					
Supply voltage	V ph Hz	230V (+/-10%) 1ph 50/60Hz			
Secondary supply voltage	V AC	230			
Digital thermostat		TX110			
<b>Compressor</b>					
Compressor type		Reciprocating			
Quantity - Number of circuits	no.	1 - 1			
Max. power draw	kW	1.15	1.5	1.6	1.92
Max. current draw	A	6.1	8.1	7.2	8.4
<b>Axial Fan</b>					
Fan type		Axial			
Quantity	no.	1		1	
Air flow rate	m³/h	2300	2650	2300	2650
Max. power draw	W	180	250	180	250
Max. current draw	A	0.81	1.1	0.81	1.1
<b>Standard Pump</b>					
Pump type		Gear pump			
Quantity	no.	1			
Nominal fluid flow rate	l/min	10		10	
Nominal available head	bar	20		20	
Max. power draw	kW	0.55		0.55	
Max. current draw	A	4.0	4.2	4.0	4.2
IN/OUT liquid connections	inch	1/2"			
Net weight (approximate)****	kg	74		75	
Width - Depth - Height	mm	800 - 450 - 495			
Sound pressure level**	dB(A)	57	60	57	60
IP rating	IP	44			
<p>* Data relating to operation under the following conditions: intake/outlet temperature 40/30°C, ISO VG 32 oil, ambient temperature 32°C. Cooling power refers to the evaporator unit.</p> <p>** Sound pressure level at 50Hz, measured in a free hemispherical field at a distance of 1 m from the machine and 1.5 metres from the ground, per ISO 3746.</p> <p>*** Weight includes pallets and packaging (where provided for), with refrigerant charge, without storage tank and axial fans.</p> <p>The electrical data refer to cos φ = 0.8.</p>					

Correction factors for calculating the cooling power												
Oil outlet temperature	Fo	°C	20	25	30	35						
		factor	0.82	0.92	1	1.05						
Ambient Temperature	Fa	°C				15	20	25	32	35	40	45
		factor				1.16	1.1	1.05	1	0.97	0.91	0.84
Oil type	Ft	type	ISO VG 10		ISO VG 22		ISO VG 32		ISO VG 46		ISO VG 68	
		factor	1.15		1.1		1		0.9		0.82	
Cooling power = Nominal cooling power x Fo x Fa x Ft												

## Industrial oil chillers

**COOLING CAPACITY**
**2300-2700 - 3600-4200 W**

### STRUCTURE

In powder-coated steel sheet, RAL 7035 textured finish. Easily removed panels

### COMPRESSOR

Hermetic scroll compressor, cooled by the refrigerant, complete with thermal cut-out.

### REFRIGERATION CIRCUIT

Complete with charging port, liquid receiver, drier filter, thermostatic valve, high- and low-pressure pressure switch, R410A refrigerant. Stepped cooling power regulation - 2 steps standard / 4 steps optional (standard on TALO6).

### EVAPORATOR

Brazed stainless-steel plate model.

### AIR CONDENSER

Microchannel condensing coil, complete with safety grille.

### AXIAL FAN

Axial fan, complete with thermal cut-out and safety grille.

### LIQUID CIRCUIT

Non-ferrous liquid circuit composed

of stainless steel centrifugal electric pump, storage tank made of plastic material complete with drain valve, electrical level indicator, 0-10 bar pressure gauge, differential pressure switch protecting the water flow, automatic by-pass and regulation sensor.

### ELECTRICAL PANEL

With main disconnect switch, relay motor protection, phase sequence relays.

### MANAGEMENT AND CONTROL

The TX350C control unit manages the operation of the chiller and provides complete operator alarm diagnostics. An on-off contact allows the machine to be switched on remotely. Illuminated control selector. RS485 connection. Possibility of remote display for machine regulation.

### PAINT/COATING

Standard colour: RAL 7035 textured.

### MAIN OPTIONS

FL - Flow switch with alarm contact

HR - Fluid heating element

OM - Unit built for outdoor operation down to -10 °C ambient temp.

OML - Unit built for outdoor operation down to -20 °C ambient temp.

FP - Polyurethane air filter

TD - Differential fluid temperature management (two sensors)

BGC - Hot gas bypass for +/- 1 K temperature precision

LS - Liquid circuit for laser application

- HIGH-pressure pump version "H" - 5 bar

### DIMENSIONS

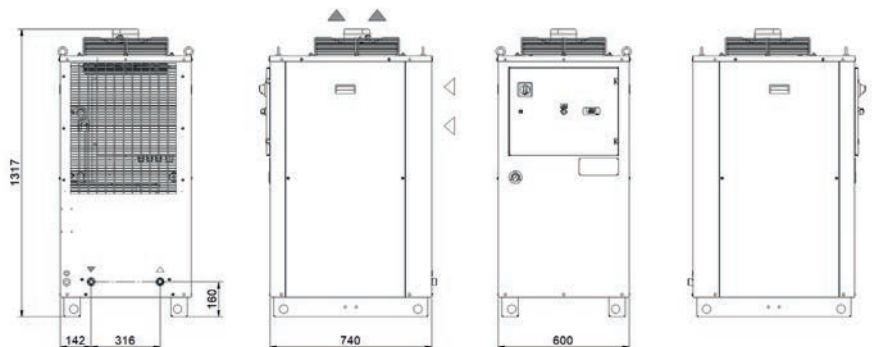

Model		TAO24		TAO37	
		50Hz	60Hz	50Hz	60Hz
<b>Rated Cooling Capacity*</b>	W	2300	2700	3600	4200
Ambient temperature operating limits	°C	+15 - +45			
Settable fluid temperature range	°C	+25 - +40			
Fluid type		ISO VG 32			
Temperature precision	K	+/-2			
Refrigerant gas	HFC	R134a			
<b>Power supply</b>					
Supply voltage	V ph Hz	230V (+/-10%) 1ph 50/60Hz			
Secondary supply voltage	V	230 V AC			
Digital thermostat		TX110			
<b>Compressor</b>					
Compressor type		Reciprocating			
Quantity - Number of circuits	no.	1 - 1			
Nominal power draw	kW	0.84	1.04	1.16	1.5
<b>Axial Fan</b>					
Fan type		Axial			
Quantity	no.	1			
Air flow rate	m <sup>3</sup> /h	1250 - 1650		1550 - 2050	
<b>Centrifugal Fan (optional)</b>					
Fan type		Centrifugal			
Quantity	no.	1			
Air flow rate	m <sup>3</sup> /h	2100 - 2400		2100 - 2400	
Available head	Pa	250			
<b>Standard Pump</b>					
Pump type		Gear pump			
Quantity	no.	1			
Nominal/max fluid flow rate	l/min	10		20	
Nominal available head	bar	10		10	
<b>Storage tank capacity (optional)</b>					
Storage tank capacity (optional)	l	50			
IN/OUT liquid connections	inch	3/4"			
Net weight (approximate)***	kg	151		153	
Width - Depth - Height	mm	600 - 740 - 1317			
Height with tank and pump	mm	1790			
Sound pressure level**	dB(A)	57	60	57	60
* Data relates to operation under the following conditions: inlet/outlet oil temp. 40/30°C, ISO VG 32 oil, ambient temperature 32°C.					
** Sound pressure level, measured in a free parallelepiped field at a distance of 1 m, per ISO 3746.					
*** Weight includes pallets and packaging (where provided for), with refrigerant charge, without storage tank and axial fans.					
The electrical data refer to cos φ = 0.8.					

Correction factors for calculating the cooling power												
Oil outlet temperature	Fo	°C	20	25	30	35						
		factor	0.59	0.77	1	1.22						
Ambient Temperature	Fa	°C				15	20	25	32	35	40	45
		factor				1.26	1.2	1.11	1	0.95	0.87	0.80
Oil type	Ft	type	ISO VG 10		ISO VG 22		ISO VG 32		ISO VG 46		ISO VG 68	
		factor	1.15		1.1		1		0.9		0.82	
Cooling power = Nominal cooling power x Fo x Fa x Ft												

## Industrial oil chillers

COOLING CAPACITY

2900 - 3600 - 4550 - 6000 - 8100 - 9550 - 10900 W



## STRUCTURE

In powder-coated steel sheet, RAL 7035 textured finish. Easily removed panels

## COMPRESSOR

Hermetic Reciprocating or Scroll compressor, cooled by the refrigerant, complete with thermal cut-out.

## REFRIGERATION CIRCUIT

Complete with charging port, drier filter, expansion or thermostatic valve, high-pressure pressure switch, R134a refrigerant.

## EVAPORATOR

Brazed stainless-steel plate model.

## AIR CONDENSER

Finned high-efficiency copper tube condensing coil, complete with safety grille.

## AXIAL FAN

Axial fan, complete with thermal cut-out and safety grille.

## HYDRAULIC CIRCUIT

Hydraulic circuit with gear pump without tank, with maximum available pressure 10 bar, 0-25 bar pressure gauge, regulation temperature sensor. Hydraulic safety with low-pressure safety pressure switch.

## ELECTRICAL PANEL

With main disconnect switch, relay motor protection, phase sequence relays.

## MANAGEMENT AND CONTROL

The TX110 control unit manages the chiller's operation, providing warnings including high/low temperature alarms and a general serious fault alarm, with the display indicating if this refers to the refrigeration or hydraulic circuit. An on-off contact allows the machine to be switched on remotely (pump included). Control disconnect switch for switching on the machine.

## PAINT/COATING

Standard colour: RAL 7035 textured.

## MAIN OPTIONS

- BA - Mechanical bypass valve protecting the pump
- LTA - Operation at low ambient temperatures
- FP - Polyurethane air filter
- RU - Castors
- TD - Differential fluid temperature management (two sensors)
- BGC - Hot gas bypass for +/- 1 K temperature precision
- BGP - Hot gas bypass for +/- 0.5 K temperature precision
- UL1 - Electrical panel and UL-certified components
- Outdoor installation options

## DIMENSIONS

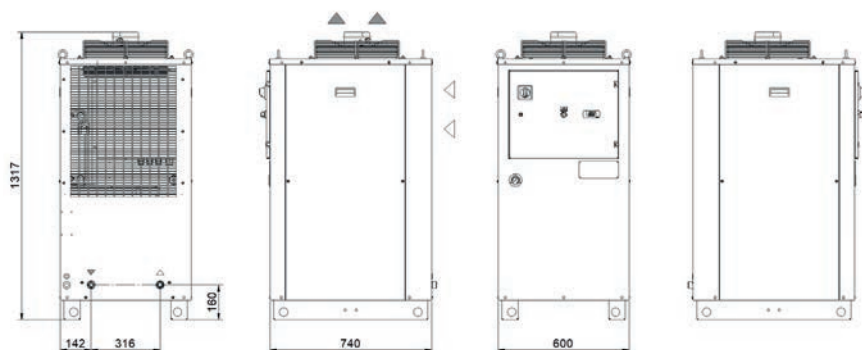

Model		TAO29	TAO37	TAO46	TAO57	TAO76	TAO93	TAOA0	
<b>Rated Cooling Capacity*</b>	W	2900	3600	4550	6000	8100	9550	10900	
Ambient temperature operating limits	°C	+15 - +45							
Settable fluid temperature range	°C	+25 - +40							
Fluid type		ISO VG 32							
Temperature precision	K	+/-2							
Refrigerant gas	HFC	R134a							
<b>Power supply</b>									
Supply voltage	V ph Hz	400V (+/-10%) 3ph 50Hz							
Secondary supply voltage	V	230 V AC							
Digital thermostat		TX110							
<b>Compressor</b>									
Compressor type		Reciprocating				Scroll			
Quantity - Number of circuits	no.	1 - 1							
Nominal power draw	kW	0.78	1.16	1.42	2.42	2.21	2.60	2.73	
<b>Axial Fan</b>									
Fan type		Axial							
Quantity	no.	1							
Air flow rate	m³/h	1550	1550	1800	1800	3150	3350	4400	
<b>Centrifugal Fan (optional)</b>									
Fan type		Centrifugal							
Quantity	no.	1							
Air flow rate	m³/h	2100 - 2400	2100 - 2400	2100 - 2400	2100 - 2400	2100 - 2400	2100 - 2400	2100 - 2400	
Available head	Pa	250							
<b>Standard Pump</b>									
Pump type		Gear pump							
Quantity	no.	1							
Nominal fluid flow rate	l/min	10	20	20	20	30	40	40	
Nominal available head	bar	10	10	10	10	10	10	10	
Storage tank capacity (optional)	l	50							
IN/OUT liquid connections	inch	3/4"							
Net weight (approximate)***	kg	151	153	155	160	165	170	175	
Width - Depth - Height	mm	600 - 740 - 1317							
Height with tank and pump	mm	1790							
Sound pressure level**	dB(A)	57	57	57	57	57	57	57	
<p>* Data relates to operation under the following conditions: inlet/outlet oil temp. 40/30°C, ISO VG 32 oil, ambient temperature 32°C.</p> <p>** Sound pressure level, measured in a free parallelepiped field at a distance of 1 m, per ISO 3746.</p> <p>*** Weight includes pallets and packaging (where provided for), with refrigerant charge, without storage tank and axial fans.</p> <p>The electrical data refer to cos φ = 0.8.</p>									

Correction factors for calculating the cooling power												
<b>Oil outlet temperature</b>	<b>Fo</b>	°C	<b>20</b>	<b>25</b>	<b>30</b>	<b>35</b>						
		factor	0.59	0.77	1	1.22						
<b>Ambient Temperature</b>	<b>Fa</b>	°C				<b>15</b>	<b>20</b>	<b>25</b>	<b>32</b>	<b>35</b>	<b>40</b>	<b>45</b>
		factor				1.26	1.2	1.11	1	0.95	0.87	0.80
<b>Oil type</b>	<b>Ft</b>	type	<b>ISO VG 10</b>		<b>ISO VG 22</b>		<b>ISO VG 32</b>		<b>ISO VG 46</b>		<b>ISO VG 68</b>	
		factor	1.15		1.1		1		0.9		0.82	
Cooling power = Nominal cooling power x Fo x Fa x Ft												

## Industrial oil chillers

COOLING CAPACITY

11400 - 12400 - 17800 - 20100 W



## STRUCTURE

In powder-coated steel sheet, RAL 7035 textured finish. Easily removed panels

## COMPRESSOR

Hermetic scroll compressor, cooled by the refrigerant, complete with thermal cut-out.

## REFRIGERATION CIRCUIT

Complete with charging port, liquid receiver, drier filter, thermostatic valve, high- and low-pressure pressure switch, R410A refrigerant.

## EVAPORATOR

Brazed stainless-steel plate model.

## AIR CONDENSER

Microchannel condensing coil, complete with safety grille.

## AXIAL FAN

Axial fan, complete with thermal cut-out and safety grille.

## HYDRAULIC CIRCUIT

Hydraulic circuit with screw pump without tank, with maximum available pressure 10 bar, high- and low-pressure safety pressure switch, 0-25 bar oil pressure gauge, regulation sensor.

## ELECTRICAL PANEL

With main disconnect switch, relay motor protection, phase sequence relays.

## MANAGEMENT AND CONTROL

The TX200 control unit manages the operation of the chiller and provides complete operator alarm diagnostics. An on-off contact allows the machine to be switched - on remotely. Illuminated control selector. Possibility of remote display for machine regulation.

## PAINT/COATING

Standard colour: RAL 7035 textured.

## MAIN OPTIONS

- BA - Mechanical bypass valve protecting the pump
- LTA - Operation at low ambient temperatures
- FP - Polyurethane air filter
- RU - Castors
- TD - Differential fluid temperature management (two sensors)
- BGC - Hot gas bypass for +/- 1 K temperature precision
- BGP - Hot gas bypass for +/- 0.5 K temperature precision
- UL1 - Electrical panel and UL-certified components
- HP/HS - Harting-type connector
- Outdoor installation options

## DIMENSIONS

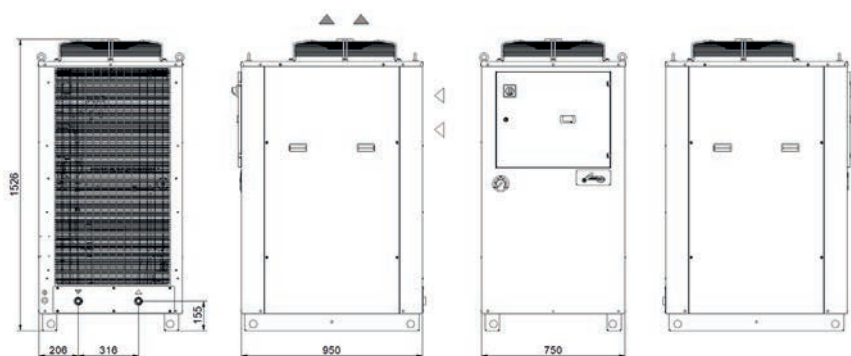

Model		TAOA1	TAOA3	TAOA5	TAOA8
<b>Rated Cooling Capacity*</b>	W	11400	12400	17800	20100
Ambient temperature operating limits	°C	+15 - +45			
Settable fluid temperature range	°C	+25 - +40			
Fluid type		ISO VG 32			
Temperature precision	K	+/-2			
Refrigerant gas	HFC	R410A			
<b>Power supply</b>					
Supply voltage	V ph Hz	400V (+/-10%) 3ph 50Hz			
Secondary supply voltage	V	24 V AC			
Digital thermostat		TX200			
<b>Compressor</b>					
Compressor type		Scroll			
Quantity - Number of circuits	no.	1 - 1			
Nominal power draw	kW	3.03	3.12	4.08	4.91
<b>Axial Fan</b>					
Fan type		Axial			
Quantity	no.	1			
Air flow rate	m³/h	6500	6500	6500	6500
<b>Centrifugal Fan (optional)</b>					
Fan type		Centrifugal			
Quantity	no.	1			
Air flow rate	m³/h	6500	6500	6500	6500
Available head	Pa	250			
<b>Standard Pump</b>					
Pump type		Screw pump			
Quantity	no.	1			
Nominal/max fluid flow rate	l/min	70	70	70	70
Nominal available head	bar	10	10	10	10
Storage tank capacity (optional)	l	130			
IN/OUT liquid connections	inch	1"			
Net weight (approximate)***	kg	200	200	235	235
Width - Depth - Height	mm	750 - 950 - 1526			
Height with tank and pump	mm	1998			
Sound pressure level**	dB(A)	67	67	67	67
<p>* Data relates to operation under the following conditions: inlet/outlet oil temp. 40/30°C, ISO VG 32 oil, ambient temperature 32°C.</p> <p>** Sound pressure level, measured in a free parallelepiped field at a distance of 1 m, per ISO 3746.</p> <p>*** Weight includes pallets and packaging (where provided for), with refrigerant charge, without storage tank and axial fans.</p> <p>The electrical data refer to cos φ = 0.8.</p>					

Correction factors for calculating the cooling power												
<b>Oil outlet temperature</b>	<b>Fo</b>	°C	<b>20</b>	<b>25</b>	<b>30</b>	<b>35</b>						
		factor	0.74	0.82	1	1.22						
<b>Ambient Temperature</b>	<b>Fa</b>	°C				<b>15</b>	<b>20</b>	<b>25</b>	<b>32</b>	<b>35</b>	<b>40</b>	<b>45</b>
		factor				1.26	1.2	1.12	1	0.95	0.87	0.80
<b>Oil type</b>	<b>Ft</b>	type	<b>ISO VG 10</b>		<b>ISO VG 22</b>		<b>ISO VG 32</b>		<b>ISO VG 46</b>		<b>ISO VG 68</b>	
		factor	1.15		1.1		1		0.9		0.82	
Cooling power = Nominal cooling power x Fo x Fa x Ft												

## Industrial oil chillers

COOLING CAPACITY

24800 - 29000 - 35800 W



## STRUCTURE

In powder-coated steel sheet, RAL 7035 textured finish. Easily removed panels

## COMPRESSOR

Hermetic scroll compressor, cooled by the refrigerant, complete with thermal cut-out.

## REFRIGERATION CIRCUIT

Complete with charging port, liquid receiver, drier filter, thermostatic valve, high- and low-pressure pressure switch, R410A refrigerant.

## EVAPORATOR

Brazed stainless-steel plate model.

## AIR CONDENSER

Microchannel condensing coil, complete with safety grille.

## AXIAL FAN

Axial fan, complete with thermal cut-out and safety grille.

## HYDRAULIC CIRCUIT

Hydraulic circuit with screw pump without tank, with maximum available pressure 10 bar, high- and low-pressure safety pressure switch, 0-25 bar oil pressure gauge, regulation sensor.

## ELECTRICAL PANEL

With main disconnect switch, relay motor protection, phase sequence relays.

## MANAGEMENT AND CONTROL

The TX200 control unit manages the operation of the chiller and provides complete operator alarm diagnostics. An on-off contact allows the machine to be switched on remotely. Illuminated control selector. Possibility of remote display for machine regulation.

## PAINT/COATING

Standard colour: RAL 7035 textured.

## MAIN OPTIONS

- BA - Mechanical bypass valve protecting the pump
- LTA - Operation at low ambient temperatures
- FP - Polyurethane air filter
- RU - Castors
- TD - Differential fluid temperature management (two sensors)
- BGC - Hot gas bypass for +/- 1 K temperature precision
- BGP - Hot gas bypass for +/- 0.5 K temperature precision
- UL1 - Electrical panel and UL-certified components
- HP/HS - Harting-type connector
- Outdoor installation options

## DIMENSIONS

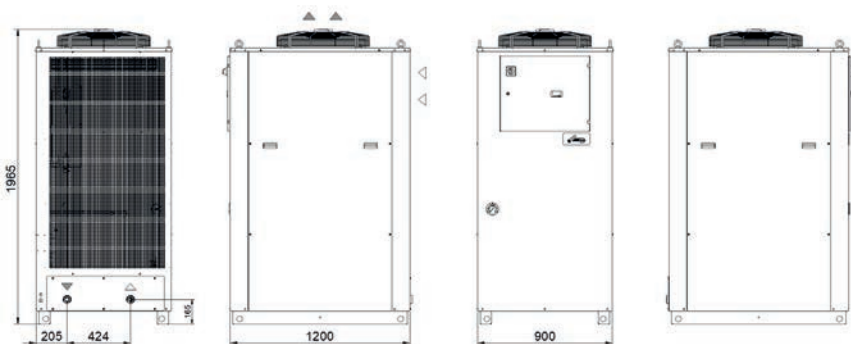



Model		TAOB5	TAOB9	TAOC5
<b>Rated Cooling Capacity*</b>	W	24800	29000	35800
Ambient temperature operating limits	°C	+15 - +45		
Settable fluid temperature range	°C	+25 - +40		
Fluid type		ISO VG 32		
Temperature precision	K	+/-2		
Refrigerant gas	HFC	R410A		
<b>Power supply</b>				
Supply voltage	V ph Hz	400V (+/-10%) 3ph 50Hz		
Secondary supply voltage	V	24 V AC		
Digital thermostat		TX200		
<b>Compressor</b>				
Compressor type		Scroll		
Quantity - Number of circuits	no.	1 - 1		
Nominal power draw	kW	6.4	7.4	8.6
<b>Axial Fan</b>				
Fan type		Axial		
Quantity	no.	1		
Air flow rate	m³/h	8300	9700	11500
<b>Centrifugal Fan (optional)</b>				
Fan type		Centrifugal		
Quantity	no.	1		
Air flow rate	m³/h	8300	9700	11500
Available head	Pa	370	180	100
<b>Standard Pump</b>				
Pump type		Screw pump		
Quantity	no.	1		
Nominal/max fluid flow rate	l/min	120	120	120
Nominal available head	bar	10	10	10
Storage tank capacity (optional)	l	130		
IN/OUT liquid connections	inch	1 1/2"		
Net weight (approximate)***	kg	260	260	260
Width - Depth - Height	mm	900 - 1200 - 1965		
Sound pressure level**	dB(A)	67	67	67
<p>* Data relates to operation under the following conditions: inlet/outlet oil temp. 40/30°C, ISO VG 32 oil, ambient temperature 32°C.</p> <p>** Sound pressure level, measured in a free parallelepiped field at a distance of 1 m, per ISO 3746.</p> <p>*** Weight includes pallets and packaging (where provided for), with refrigerant charge, without storage tank and axial fans.</p> <p>The electrical data refer to <math>\cos \phi = 0.8</math>.</p>				

Correction factors for calculating the cooling power												
Oil outlet temperature	Fo	°C	20	25	30	35						
		factor	0.71	0.84	1	1.18						
Ambient Temperature	Fa	°C				15	20	25	32	35	40	45
		factor				1.25	1.2	1.09	1	0.97	0.91	0.87
Oil type	Ft	type	ISO VG 10		ISO VG 22		ISO VG 32		ISO VG 46		ISO VG 68	
		factor	1.15		1.1		1		0.9		0.82	
Cooling power = Nominal cooling power x Fo x Fa x Ft												

## Industrial oil chillers

COOLING CAPACITY

40000 - 47000 - 55000 - 67000 W



## STRUCTURE

In powder-coated steel sheet, RAL 7035 textured finish. Easily removed panels.

## COMPRESSOR

Hermetic scroll compressor, cooled by the refrigerant, complete with thermal cut-out.

## REFRIGERATION CIRCUIT

Complete with charging port, liquid receiver, drier filter, thermostatic valve, high- and low-pressure pressure switch, R410A refrigerant. Optional 2-step cooling power regulation (standard on TAOF8).

## EVAPORATOR

Brazed stainless-steel plate model.

## AIR CONDENSER

Microchannel condensing coil, complete with safety grille.

## AXIAL FAN

Axial fan, complete with thermal cut-out and safety grille..

## HYDRAULIC CIRCUIT

Hydraulic circuit with screw pump without tank, with maximum available pressure 10 bar, 0-25 bar pressure gauge, regulation temperature sensor. Hydraulic safety with protective flow switch.

## ELECTRICAL PANEL

With main disconnect switch, relay motor protection, phase sequence relays.

## MANAGEMENT AND CONTROL

The TX350C control unit manages the operation of the chiller and provides complete operator alarm diagnostics. An on-off contact allows the machine to be switched on remotely. Illuminated control selector. RS485 connection. Possibility of remote display for machine regulation.

## PAINT/COATING

Standard colour: RAL 7035 textured.

## MAIN OPTIONS

- BA - Mechanical bypass valve protecting the pump
- LTA - Operation at low ambient temperatures
- OM - Unit built for outdoor operation down to -10 °C ambient temp.
- FP - Polyurethane air filter
- TD - Differential fluid temperature management (two sensors)
- BGC - Hot gas bypass for +/- 1 K temperature precision
- UL1 - Electrical panel and UL-certified components
- Outdoor installation options

## DIMENSIONS

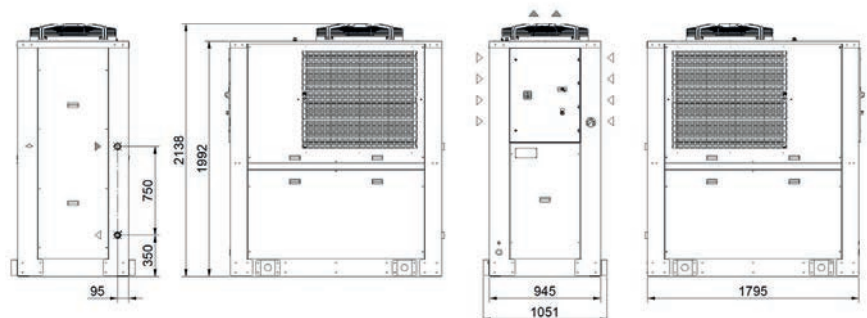

Model		TAOD0	TAOD9	TAOE6	TAOF8
<b>Rated Cooling Capacity*</b>	W	40000	47000	55000	67000
Ambient temperature operating limits	°C	+15 - +45			
Settable fluid temperature range	°C	+25 - +40			
Fluid type		ISO VG 32			
Temperature precision	K	+/-2			
Refrigerant gas	HFC	R410A			
<b>Power supply</b>					
Supply voltage	V ph Hz	400V (+/-10%) 3ph 50Hz			
Secondary supply voltage	V	24 V AC			
Digital thermostat		TX350C			
<b>Compressor</b>					
Compressor type		Scroll			
Quantity - Number of circuits	no.	1 - 1			2 - 1
Max. power draw	kW	9.4	10.4	12.1	25.0
<b>Axial Fan</b>					
Fan type		Axial			
Quantity	no.	1	1	1	1
Air flow rate	m <sup>3</sup> /h	12600	14400	16000	24000
<b>Centrifugal Fan (optional)</b>					
Fan type		Centrifugal			
Quantity	no.	1	1	1	1
Air flow rate	m <sup>3</sup> /h	12600	14400	16000	24000
Available head	Pa	570	350	200	150
<b>Standard Pump</b>					
Pump type		Screw pump			
Quantity	no.	1	1	1	1
Nominal/max fluid flow rate	l/min	135	160	190	230
Nominal available head	bar	10	10	10	10
Storage tank capacity (optional)	l	200			
IN/OUT liquid connections	inch	1 1/2"			
Net weight (approximate)***	kg	580	600	600	600
Width - Depth - Height	mm	945 - 1795 - 2138			
Sound pressure level**	dB(A)	75	75	75	78

\* Data relates to operation under the following conditions: inlet/outlet oil temp. 40/30°C, ISO VG 32 oil, ambient temperature 32°C.

\*\* Sound pressure level, measured in a free parallelepiped field at a distance of 1 m, per ISO 3746.

\*\*\* Weight includes pallets and packaging (where provided for), with refrigerant charge, without storage tank and axial fans.

The electrical data refer to  $\cos \phi = 0.8$ .

Correction factors for calculating the cooling power												
Oil outlet temperature	Fo	°C	20	25	30	35						
		factor	0.75	0.83	1	1.20						
Ambient Temperature	Fa	°C				15	20	25	32	35	40	45
		factor				1.27	1.2	1.13	1	0.95	0.86	0.80
Oil type	Ft	type	ISO VG 10		ISO VG 22		ISO VG 32		ISO VG 46		ISO VG 68	
		factor	1.15		1.1		1		0.9		0.82	
Cooling power = Nominal cooling power x Fo x Fa x Ft												

# TCI

## Immersion coil chillers

The new TCI range of chillers from **texa industries**, featuring immersion coil evaporators, is **texa industries'** answer to any oil/water cooling requirements for industrial applications.



# TCI56÷91 Size 2

## Immersion coil chillers

**COOLING CAPACITY**

**6000 - 7100 - 8100 - 9650 - 9200 - 11000 W**



### STRUCTURE

In powder-coated steel sheet, RAL 7035 textured finish. Easily removed panels

### COMPRESSOR

Hermetic SCROLL compressor, cooled by the refrigerant, complete with thermal cut-out.

### REFRIGERATION CIRCUIT

Complete with charging port, drier filter, thermostatic valve, high- and low-pressure pressure switch, refrigerant gas.

### EVAPORATOR

Dual concentric coil in AISI 304 stainless steel. Resin-covered stainless-steel regulation sensor, IP67 rated.

### AIR CONDENSER

Finned high-efficiency copper tube condensing coil, complete with safety grille.

### AXIAL FAN

Axial fan, complete with thermal cut-out and safety grille. On request, centrifugal fan for air expulsion ducting

### ELECTRICAL PANEL

With main disconnect switch, fused motor protection.

### MANAGEMENT AND CONTROL

The TX110 control unit manages the chiller's operation, providing warnings including high/low temperature alarms and a general serious fault alarm, with the display indicating if this refers to the refrigeration circuit or protection of the immersion coils. An on-off contact allows the machine to be switched on remotely. Control disconnect switch for switching on the machine.

### PAINT/COATING

Standard colour: RAL 7035 textured.

### MAIN OPTIONS

- FP - Polyurethane air filter
- TD - Differential fluid temperature management (two sensors)
- BGP - Hot gas bypass for +/- 0.5 K temperature precision
- Agitator for fluid movement
- Non-standard paint/coating
- Satin AISI 304 stainless steel framework
- Design of higher cooling powers with dedicated framework
- Centrifugal fans for condensation air ducting

### DIMENSIONS

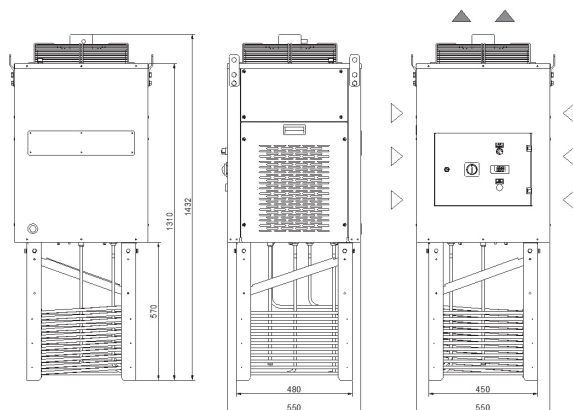

Model		TCI56		TCI70		TCI91	
		50Hz	60Hz	50Hz	60Hz	50Hz	60Hz
Rated Cooling Capacity*	W	6000	7100	8100	9650	9200	11000
Ambient temperature operating limits	°C	-5 - +45					
Settable fluid temperature range	°C	+15 / +25 water or emulsion max 5 cSt - 40°C +20 / +30 mineral oil 32 cSt - 40°C					
Temperature precision	K	+/- 1					
Refrigerant gas	HFC	R134a					
Minimum fluid flow rate (emulsion/oil)	l/min	40 - 60					
Minimum volume in tank (emulsion/oil)	l.	60 - 100					
<b>Power supply</b>							
Supply voltage	V ph Hz	400/460V (+/-10%) 3ph 50/60Hz					
Secondary supply voltage	V	230V-24V AC					
Digital thermostat		TX110					
<b>Compressor</b>							
Compressor type		Scroll					
Quantity - Number of circuits	no.	1 - 1					
Max. power draw	kW	3	3.6	3.5	4.2	4.1	4.9
Max. current draw	A	5.6	6.7	6.4	7.7	7.1	8.5
<b>Axial Fan</b>							
Fan type		Axial					
Quantity	no.	1					
Air flow rate	m³/h	2000					
Max. power draw	kW	0.18	0.25	0.18	0.25	0.18	0.25
Max. current draw	A	0.81	1.1	0.81	1.1	0.81	1.1
<b>Net weight (approximate)***</b>							
	kg	145		147		150	
Width - Depth - Height	mm	550 - 550 - 1432					
Sound pressure level**	dB(A)	57		57		57	
IP rating	IP	44					
<p>* Data relates to operation under the following conditions: Ambient temperature 32°C.  ** Sound pressure level at 50Hz, measured in a free hemispherical field at a distance of 1 m from the machine and 1.5 metres from the ground, per ISO 3746.  *** Weight includes pallets and packaging (where provided for), with refrigerant charge and axial fans.  The electrical data refer to cos φ = 0.8.</p>							

Correction factors for calculating the cooling power								
Ambient Temperature	Emulsion	Oil	Cooling capacity					
32	15	20	4620	5467	6237	7431	7084	8470
	20	25	5460	6461	7371	8782	8372	10010
	25	30	6000	7100	8100	9650	9200	11000
37	15	20	4332	5126	5848	6967	6642	7942
	20	25	5187	6138	7002	8342	7953	9510
	25	30	5700	6745	7695	9168	8740	10450
42	15	20	4066	4811	5489	6539	6234	7454
	20	25	4805	5686	6486	7728	7367	8809
	25	30	5280	6248	7128	8492	8096	9680

# TCIA2÷A7 Size 3

## Immersion coil chillers

### COOLING CAPACITY

12300 - 14600 - 16400 - 19400 - 17800 - 20450 W



### STRUCTURE

In powder-coated steel sheet, RAL 7035 textured finish. Easily removed panels

### COMPRESSOR

Hermetic SCROLL compressor, cooled by the refrigerant, complete with thermal cut-out.

### REFRIGERATION CIRCUIT

Complete with charging port, drier filter, thermostatic valve, high- and low-pressure pressure switch, refrigerant gas.

### EVAPORATOR

Dual concentric coil in AISI 304 stainless steel. Resin-covered stainless-steel regulation sensor, IP67 rated.

### AIR CONDENSER

Finned high-efficiency copper tube condensing coil, complete with safety grille.

### AXIAL FAN

Axial fan, complete with thermal cut-out and safety grille. On request, centrifugal fan for air expulsion ducting

### ELECTRICAL PANEL

With main disconnect switch, fused motor protection.

### MANAGEMENT AND CONTROL

The TX110 control unit manages the chiller's operation, providing warnings including high/low temperature alarms and a general serious fault alarm, with the display indicating if this refers to the refrigeration circuit or protection of the immersion coils. An on-off contact allows the machine to be switched on remotely. Control disconnect switch for switching on the machine.

### PAINT/COATING

Standard colour: RAL 7035 textured.

### MAIN OPTIONS

- FP - Polyurethane air filter
- TD - Differential fluid temperature management (two sensors)
- BGP - Hot gas bypass for +/- 0.5 K temperature precision
- Agitator for fluid movement
- Non-standard paint/coating
- Satin AISI 304 stainless steel framework
- Design of higher cooling powers with dedicated framework
- Centrifugal fans for condensation air ducting

### DIMENSIONS

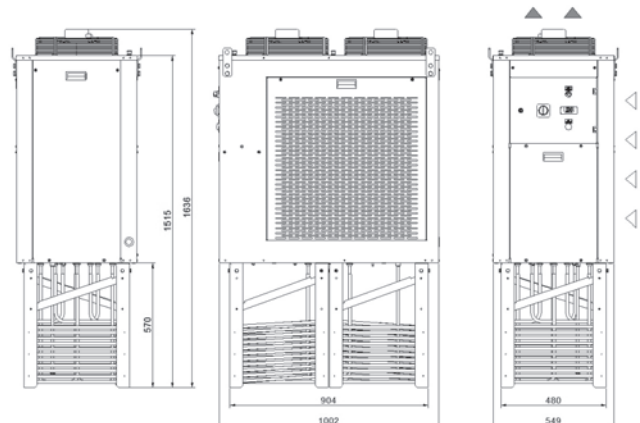



Model		TCIA2		TCIA4		TCIA7	
		50Hz	60Hz	50Hz	60Hz	50Hz	60Hz
Rated Cooling Capacity*	W	12300	14600	16400	19400	17800	20450
Ambient temperature operating limits	°C	-5 - +45					
Settable fluid temperature range	°C	+15 / +25 water or emulsion max 5 cSt - 40°C +20 / +30 mineral oil 32 cSt - 40°C					
Temperature precision	K	+/- 1					
Refrigerant gas	HFC	R410A					
Minimum fluid flow rate (emulsion/oil)	l/min	80 - 120					
Minimum volume in tank (emulsion/oil)	l.	150 - 250					
<b>Power supply</b>							
Supply voltage	V ph Hz	400/460V (+/-10%) 3ph 50/60Hz					
Secondary supply voltage	V	230V-24V AC					
Digital thermostat		TX110					
<b>Compressor</b>							
Compressor type		Scroll					
Quantity - Number of circuits	no.	1 - 1					
Max. power draw	kW	3.1	3.5	4.0	4.3	4.1	4.7
Max. current draw	A	9.8	9.6	12.1	11.8	12.5	12.1
<b>Axial Fan</b>							
Fan type		Axial					
Quantity	no.	2					
Air flow rate	m³/h	4300					
Max. power draw	kW	0.4	0.55	0.4	0.55	0.4	0.55
Max. current draw	A	1.7	2.2	1.7	2.2	1.7	2.2
<b>Net weight (approximate)***</b>							
Net weight (approximate)***	kg	215		215		215	
Width - Depth - Height	mm	549 - 1002 - 1636					
Sound pressure level**	dB(A)	60		60		60	
IP rating	IP	44					

\* Data relates to operation under the following conditions: Ambient temperature 32°C.

\*\* Sound pressure level at 50Hz, measured in a free hemispherical field at a distance of 1 m from the machine and 1.5 metres from the ground, per ISO 3746.

\*\*\* Weight includes pallets and packaging (where provided for), with refrigerant charge and axial fans.

The electrical data refer to cos φ = 0.8.

Correction factors for calculating the cooling power								
Ambient Temperature	Emulsion	Oil	Cooling capacity					
32	15	20	9471	11242	12628	15154	13706	15747
	20	25	11193	13286	14924	17909	16198	18610
	25	30	12300	14600	16400	19400	17800	20450
37	15	20	8881	10541	11841	14209	12852	14765
	20	25	10633	12622	14178	17014	15388	17679
	25	30	11685	13870	15580	18696	16910	19428
42	15	20	8334	9893	11113	13336	12061	13857
	20	25	9850	11692	13133	15760	14254	16376
	25	30	10824	12848	14432	17318	15664	17996

# TAU

## Industrial chillers for contaminated or dirty fluids

Thanks to the tube bundle heat exchanger, the TAU range allows dirty fluids to be cooled while guaranteeing the highest levels of performance and the lowest maintenance costs



## Industrial chillers for contaminated or dirty fluids

COOLING CAPACITY

2300/2700 - 3600/4200 W



## STRUCTURE

In powder-coated steel sheet, RAL 7035 textured finish. Easily removed panels.

## COMPRESSOR

Hermetic reciprocating compressor, cooled by the refrigerant, complete with thermal cut-out.

## REFRIGERATION CIRCUIT

Complete with charging port, drier filter, expansion valve, high-pressure pressure switch, R134a refrigerant.

## EVAPORATOR

Tube bundle heat exchanger (allows for inspection).

## AIR CONDENSER

Microchannel condensing coil, complete with safety grille.

## AXIAL FAN

Axial fan, complete with thermal cut-out and safety grille.

## LIQUID CIRCUIT

Non-ferrous liquid circuit composed of peripheral electric pump, or, 0-10 bar pressure gauge, protective flow switch, regulation sensor.

## ELECTRICAL PANEL

With main disconnect switch, fused motor protection.

## MANAGEMENT AND CONTROL

The TX110 control unit manages the chiller's operation, providing warnings including high/low temperature alarms and a general serious fault alarm, with the display indicating if this refers to the refrigeration or liquid circuit. An on-off contact allows the machine to be switched on remotely (pump included). Control disconnect switch for switching on the machine.

## PAINT/COATING

Standard colour: RAL 7035 textured.

## MAIN OPTIONS

- BA - Mechanical bypass valve protecting the pump
- LTA - Operation at low ambient temperatures
- FP - Polyurethane air filter
- RU - Castors
- TD - Differential fluid temperature management (two sensors)
- BGC - Hot gas bypass for +/- 1 K temperature precision
- BGP - Hot gas bypass for +/- 0.5 K temperature precision
- UL1 - Electrical panel and UL-certified components
- HIGH-pressure pump version "H" - 5 bar, version "R" - 7 bar.
- Outdoor installation options

## DIMENSIONS

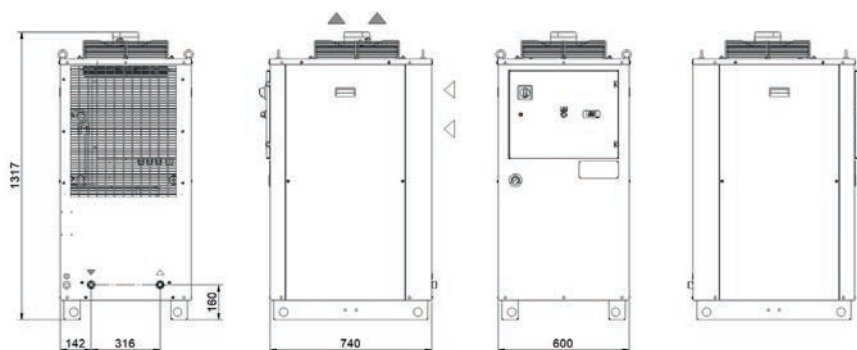

Model		TAU24		TAU37	
		50Hz	60Hz	50Hz	60Hz
<b>Rated Cooling Capacity*</b>	W	2300	2700	3600	4200
Ambient temperature operating limits	°C	+15 - +45			
Settable fluid temperature range	°C	+25 - +40			
Fluid type		Emulsion 90% water - 10% oil			
Temperature precision	K	+/-2			
Refrigerant gas	HFC	R134a			
<b>Power supply</b>					
Supply voltage	V ph Hz	230V (+/-10%) 1ph 50 or 60Hz			
Secondary supply voltage	V	230 V AC			
Digital thermostat		TX110			
<b>Compressor</b>					
Compressor type		Reciprocating			
Quantity - Number of circuits	no.	1 - 1			
Nominal power draw	kW	0.84	1.04	1.16	1.5
<b>Axial Fan</b>					
Fan type		Axial			
Quantity	no.	1			
Air flow rate	m <sup>3</sup> /h	1250 - 1650		1550 - 2050	
<b>Centrifugal Fan (optional)</b>					
Fan type		Centrifugal			
Quantity	no.	1			
Air flow rate	m <sup>3</sup> /h	2100 - 2400		2100 - 2400	
Available head	Pa	250			
<b>Standard Pump</b>					
Pump type		Centrifugal			
Quantity	no.	1			
Nominal/max fluid flow rate	l/min	5		8	
Nominal available head	bar	3	3	3	3
Storage tank capacity	l	50			
IN/OUT liquid connections	inch	3/4"			
Net weight (approximate)***	kg	151		153	
Width - Depth - Height	mm	600 - 740 - 1317			
Sound pressure level**	dB(A)	57	60	57	60
<p>* Data relates to operation under the following conditions: inlet/outlet temp. 37/30°C, 90% water - 10% oil emulsion, ambient temperature 32°C.</p> <p>** Sound pressure level, measured in a free parallelepiped field at a distance of 1 m, per ISO 3746.</p> <p>*** Weight includes pallets and packaging (where provided for), with refrigerant charge, storage tank empty, axial fans.</p> <p>The electrical data refer to cos φ = 0.8.</p>					

Correction factors for calculating the cooling power												
<b>90% water - 10% ISO VG 32 oil emulsion outlet temperature</b>	<b>Fo</b>	°C	20	25	30	35						
		factor	0.59	0.77	1	1.22						
<b>Ambient Temperature</b>	<b>Fa</b>	°C				15	20	25	32	32	40	45
		factor				1.26	1.2	1.11	1	0.95	0.87	0.8
<b>Oil type</b>	<b>Ft</b>	%	water	90% water-10% ISO VG 32 oil		70% water-30% ISO VG 32 oil		40% water-60% ISO VG 32 oil		100% ISO VG 32		
		factor	1.05	1		0.9		0.74		0.53		
Cooling Power = Nominal Cooling Power x Fo x Fa x Ft												

## Industrial chillers for contaminated or dirty fluids

### COOLING CAPACITY

2900 - 3600 - 4550 - 6000 - 8100 - 9550 - 10900 W



### LIQUID CIRCUIT

Non-ferrous liquid circuit composed of peripheral electric pump, storage tank made of plastic material complete with integrated visual level indicator, 0-10 bar pressure gauge, protective flow switch, regulation sensor.

### ELECTRICAL PANEL

With main disconnect switch, fused motor protection.

### MANAGEMENT AND CONTROL

The TX110 control unit manages the chiller's operation, providing warnings including high/low temperature alarms and a general serious fault alarm, with the display indicating if this refers to the refrigeration or liquid circuit. An on-off contact allows the machine to be switched on remotely (pump included). Control disconnect switch for switching on the machine.

### STRUCTURE

In powder-coated steel sheet, RAL 7035 textured finish. Easily removed panels.

### COMPRESSOR

Hermetic reciprocating compressor, cooled by the refrigerant, complete with thermal cut-out.

### REFRIGERATION CIRCUIT

Complete with charging port, drier filter, expansion valve, high-pressure pressure switch, R134a refrigerant.

### EVAPORATOR

Tube bundle heat exchanger (allows for inspection).

### AIR CONDENSER

Microchannel condensing coil, complete with safety grille.

### AXIAL FAN

Axial fan, complete with thermal cut-out and safety grille.

### PAINT/COATING

Standard colour: RAL 7035 textured.

### MAIN OPTIONS

- BA - Mechanical bypass valve protecting the pump
- LTA - Operation at low ambient temperatures
- FP - Polyurethane air filter
- RU - Castors
- TD - Differential fluid temperature management (two sensors)
- BGC - Hot gas bypass for +/- 1 K temperature precision
- BGP - Hot gas bypass for +/- 0.5 K temperature precision
- UL1 - Electrical panel and UL-certified components
- HIGH-pressure pump version "H" - 5 bar, version "R" - 7 bar.
- Outdoor installation options

### DIMENSIONS

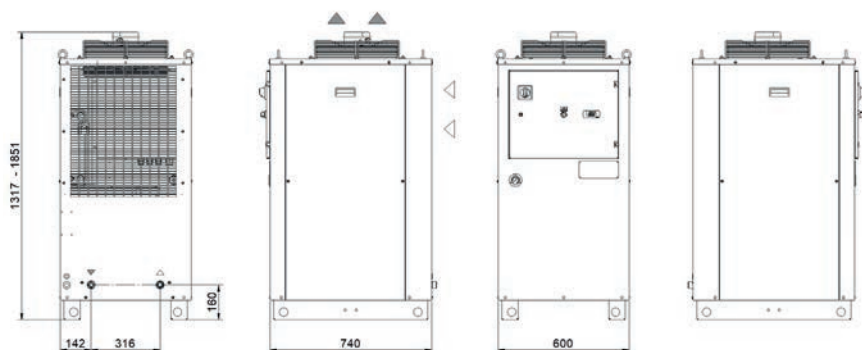

Model		TAU29	TAU37	TAU46	TAU57	TAU76	TAU93	TAUA0	
<b>Rated Cooling Capacity*</b>	W	2900	3600	4550	6000	8100	9550	10900	
Ambient temperature operating limits	°C	+15 - +45							
Settable fluid temperature range	°C	+25 - +40							
Fluid type		Emulsion 90% water - 10% oil							
Temperature precision	K	+/-2							
Refrigerant gas	HFC	R134a							
<b>Power supply</b>									
Supply voltage	V ph Hz	400V (+/-10%) 3ph 50Hz							
Secondary supply voltage	V	230 V AC							
Digital thermostat		TX110							
<b>Compressor</b>									
Compressor type		Reciprocating				Scroll			
Quantity - Number of circuits	no.	1 - 1							
Nominal power draw	kW	0.78	1.16	1.42	2.42	2.21	2.60	2.73	
<b>Axial Fan</b>									
Fan type		Axial							
Quantity	no.	1							
Air flow rate	m³/h	1550	1550	1800	1800	3150	3350	4400	
<b>Centrifugal Fan (optional)</b>									
Fan type		Centrifugal							
Quantity	no.	1							
Air flow rate	m³/h	2100 - 2400	2100 - 2400	2100 - 2400	2100 - 2400	2100 - 2400	2100 - 2400	2100 - 2400	
Available head	Pa	250							
<b>Standard Pump</b>									
Pump type		Centrifugal							
Quantity	no.	1							
Nominal/max fluid flow rate	l/min	6.5	8	10	13.5	18	21	24	
Nominal available head	bar	3	2.9	2.8	2.7	3.1	3	2.8	
Storage tank capacity	l	50							
IN/OUT liquid connections	inch	3/4"							
Net weight (approximate)***	kg	151	153	155	160	165	170	175	
Width - Depth	mm	600 - 740							
Height	mm	1317				1851			
Sound pressure level**	dB(A)	57	57	57	57	57	57	57	
* Data relates to operation under the following conditions: inlet/outlet temp. 37/30°C, 90% water - 10% oil emulsion, ambient temperature 32°C.									
** Sound pressure level, measured in a free parallelepiped field at a distance of 1 m, per ISO 3746.									
*** Weight includes pallets and packaging (where provided for), with refrigerant charge, storage tank empty, axial fans.									
The electrical data refer to cos φ = 0.8.									

Correction factors for calculating the cooling power												
<b>90% water - 10% ISO VG 32 oil emulsion outlet temperature</b>	<b>Fo</b>	°C	20	25	30	35						
		factor	0.59	0.77	1	1.22						
<b>Ambient Temperature</b>	<b>Fa</b>	°C				15	20	25	32	32	40	45
		factor				1.26	1.2	1.11	1	0.95	0.87	0.8
<b>Oil type</b>	<b>Ft</b>	%	water	90% water -10% ISO VG 32 oil		70% water -30% ISO VG 32 oil		40% water -60% ISO VG 32 oil		100% ISO VG 32		
		factor	1.05	1		0.9		0.74		0.53		
Cooling Power = Nominal Cooling Power x Fo x Fa x Ft												

# SAW

## Water-air heat exchangers

The most simple and cost-effective system for cooling of fluids in industrial processes through the ambient air.





# SAW50

## Water-air heat exchangers

**COOLING CAPACITY**
**5000-5650 W**

### STRUCTURE

in polyester powder-coated steel sheet.

### AXIAL FAN

Aluminium axial fan, diameter 250 mm.

### LIQUID CIRCUIT

Liquid circuit composed entirely of non-ferrous material in contact with the liquid to prevent contamination. Brass electric pump with 3 bar available head with thermal cut-out. Storage tank, complete with filling. Protective water flow switch.

### COOLING COIL

Dual finned aluminium cooling coil with copper tubes.

### MANAGEMENT AND CONTROL

Power supply cable: 1.5 m.

### PAINT/COATING

Standard colour: RAL 7035 textured.

### MAIN OPTIONS

LE - Electrical level indicator

FP - Polyurethane air filter

TR - Digital regulation thermostat, temperature display complete with NTC sensor

RU - Castors

AV - Vibration damper supports

Others on customer request

### DIMENSIONS

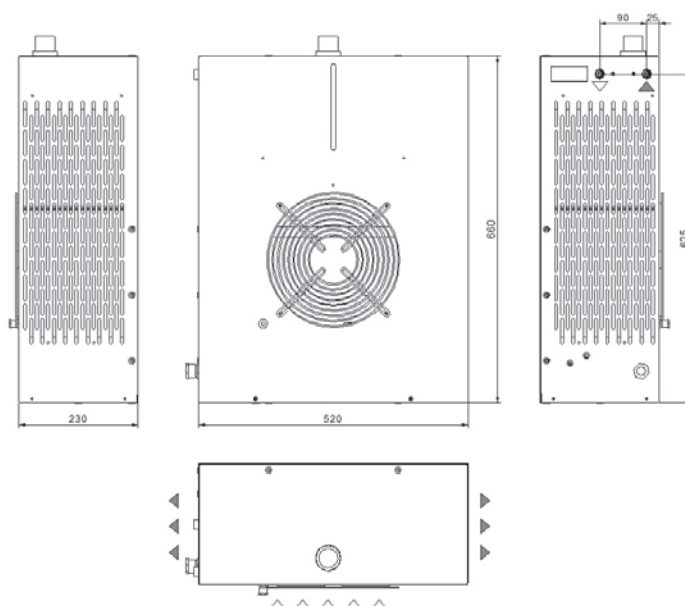

Model		SAW50	
		50Hz	60Hz
Rated Cooling Capacity*	W	5000	5650
Max. ambient operating temp.	°C	50	
Fluid type		Water	
Power supply			
Supply voltage	V ph Hz	230V (+/-10%) 1ph 50/60Hz	
Axial Fan			
Fan type		Axial	
Quantity	no.	1 x d.250 mm	
Air flow rate	m³/h	1500 - 1725	
Standard Pump			
Pump type		Peripheral	
Quantity	no.	1	
Nominal/max fluid flow rate	l/min	10.0 - 16.0	13.5 - 18.0
Nominal available head	bar	2.8	
Max. power draw	kW	0.65	0.70
Max. current draw	A	3.4	4.6
Storage tank capacity			
Storage tank capacity	l	5	
IN/OUT liquid connections	inch	1/4"	
Net weight (approximate)***	kg	19	
Width - Depth - Height	mm	520 - 230 - 660	
Sound pressure level**	dB(A)	38	
IP rating	IP	34	

\* Data relates to operation under the following conditions: outlet temp. 50°C water, ambient temperature 35°C.

\*\* Sound pressure level at 50Hz, measured in a free hemispherical field at a distance of 1 m from the machine and 1.5 metres from the ground, per ISO 3746.

\*\*\* Weights with storage tank empty and all packaging removed.

The electrical data refer to  $\cos \phi = 0.8$ .

Correction factors for calculating the cooling power												
T water- T ambient $\Delta T$	Fw	°C		5	10	15	20	25	30	35	40	
		factor		0.38	0.67	1.00	1.30	1.67	1.91	2.32	2.55	
Percentage glycol by weight	Fg	%		0	10	15	20	25	30	35	40	
		factor		1.00	0.97	0.96	0.95	0.94	0.93	0.91	0.90	
Cooling power = Nominal cooling power x Fo x Fa x Ft												

# SAWA0

## Water-air heat exchangers

**COOLING CAPACITY**
**10000 W**

### STRUCTURE

In polyester powder-coated steel sheet.

### AXIAL FAN

Axial fan in aluminium.

### LIQUID CIRCUIT

Liquid circuit composed entirely of non-ferrous material in contact with the liquid to prevent contamination. Stainless-steel electric pump with available head of over 3.5 bar, with thermal cut-out. Storage tank, complete with filling.

### COOLING COIL

Microchannel heat exchanger.

### MANAGEMENT AND CONTROL

Power supply cable: 1.5 m.

### PAINT/COATING

Standard colour: RAL 7035 textured.

### MAIN OPTIONS

LE - Electrical level indicator

FP - Polyurethane air filter

TR - Digital regulation thermostat, temperature display complete with NTC sensor

RU - Castors

AV - Vibration damper supports

Others on customer request

### DIMENSIONS

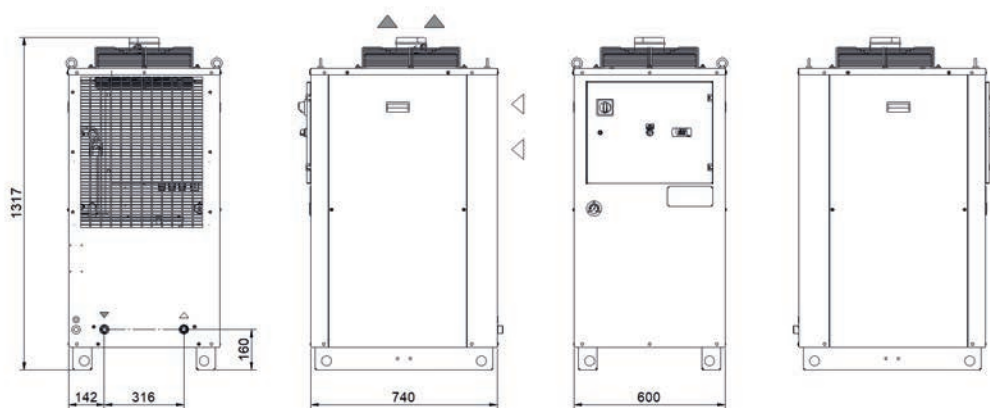

Model		SAWA0
Rated Cooling Capacity*	W	10000
Max. ambient operating temp.	°C	50
Fluid type		Water
Power supply		
Supply voltage	V ph Hz	230V (+/-10%) 1ph 50Hz
Axial Fan		
Fan type		Axial
Quantity	no.	1
Air flow rate	m³/h	2500 - 2850
Standard Pump		
Pump type		Peripheral
Quantity	no.	1
Nominal/max fluid flow rate	l/min	32 - 80
Nominal available head	bar	3.5
Max. power draw	kW	1.5
Max. current draw	A	6.5
Storage tank capacity		
Storage tank capacity	l	50
IN/OUT liquid connections	inch	3/4"
Net weight (approximate)***	kg	90
Width - Depth - Height	mm	600 - 740 - 1317
Sound pressure level**	dB(A)	38
IP rating	IP	44

\* Data relates to operation under the following conditions: outlet temp. 50°C water, ambient temperature 35°C.

\*\* Sound pressure level, measured in a free hemispherical field at a distance of 1 m from the machine and 1.5 metres from the ground, per ISO 3746.

\*\*\* Weights with storage tank empty and all packaging removed.

The electrical data refer to  $\cos \phi = 0.8$ .

#### Correction factors for calculating the cooling power

T water- T ambient ΔT	Fw	°C	5	10	15	20	25	30	35	40
		factor		0.38	0.67	1.00	1.30	1.67	1.91	2.32
Percentage glycol by weight	Fg	%	0	10	15	20	25	30	35	40
		factor		1.00	0.97	0.96	0.95	0.94	0.93	0.91

$$\text{Cooling power} = \text{Nominal cooling power} \times F_o \times F_a \times F_t$$

# TEXA FLUID

## Chemical additives for industrial cooling circuits

### INTRODUCTION

Texa industries, thanks to its experience in manufacturing industrial cooling systems, has developed multiple liquid solutions for industrial systems to be used with or without mixing with water. Whenever water is used as the heat transfer medium in circuits, the use of these liquid solutions offers complete protection of the liquid system, also guaranteeing that the heat transfer capacity is maintained. These products have been designed to limit the onset of problems such as corrosion, the formation of deposits and scale, bacteriological phenomena, reduction in performance, increases in maintenance costs, unexpected stoppages and reduction of the average lifespan of the systems. The phenomenon which causes the greatest number of problems in circuits is CORROSION. The water present in the systems tends to form scale deposits and bacterial slime, and above all encourages corrosion caused by the metal being attacked by the oxygen it contains. The use of high-purity water (demineralised, RO purified and in some cases softened) prevents the formation of scale but significantly increases corrosion issues.

The main causes of corrosion are:

**OXIDATION** of the metals due to the oxygen dissolved in the water;

**ACID** produced by the breakdown of glycol over time.

Texa industries therefore decided to develop multiple solutions to meet customer requirements in order to prevent damage to industrial systems, particularly closed circuits (at atmospheric and other pressures).

**WARNING:** For detailed information on the toxicity and other safety factors relating to any type of fluid, refer to the MSDS provided by texa industries.



### TEXA FLUID 903-TX

Product code: C15001209-25kg can - C15002650-10kg can

This is a liquid solution based on 93% ethylene glycol with the addition of inhibitors and biocides. The product is compatible with all the most common metals (iron, steel, copper and its alloys, aluminium and its alloys), as well as plastic and rubber. Designed to protect liquid circuits in industrial machines, machine tools and all those systems where the recirculation of cold or hot water in multi-metal circuits is necessary. It is formulated with substances which provide three key actions to protect the system:

**ANTIFREEZE ACTION:** prevents the formation of ice at temperatures around zero;

**CORROSION INHIBITION:** prevents corrosion by forming a protective film on metal surfaces.

**BIOCIDAL ACTION:** inhibits growth of fungi, moulds and bacteria, preventing slime build-up.

Do not mix with softened, demineralised and RO purified water.



### TEXA FLUID 903-TX-MIXED

Product code: C15001218-25 kg can

This is a liquid solution based on 30% ethylene glycol with the addition of inhibitors and biocides, and mixed with 70 % water. Retains the same chemical characteristics as 903-TX.



### **TEXA FLUID BIOCIDAL-ALGICIDE FLUID**

Product code: C15003950-25kg can - C15003930-1kg can

This is a biocide formulation based on isothiazolinone with an excellent algicidal and biomass dispersion action. It is used to control biological pollution in open recirculated or similar cooling circuits. It penetrates the biological masses thanks to its effective dispersive action, guaranteeing the best possible cleaning of the heat exchange surfaces. This liquid, as well as having a powerful biocidal and algicidal effect, also has low levels of toxicity. The use of this liquid is particularly recommended for softened, demineralised and RO purified water (laser applications).



### **TEXA FLUID CORROSION INHIBITOR**

Product code: C15003949-25kg can - C15003929-1kg can

This is a highly ecological formulation which prevents corrosion in closed recirculated hot and cold water circuits. The presence of a strong inorganic anodic inhibitor, which is ecologically compatible, together with organic inhibitors and polymer dispersants, provides excellent protection from corrosion for ferrous and cupric metals and alloys and excellent cleaning of the heat exchange surfaces, preventing the formation of any kind of deposits. Also compatible with non-metallic components.



### **TEXA FLUID FOOD**

Product code: C15004334-25 kg can

This is a multifunctional diathermic fluid based on FDA approved inhibited mono ethylene glycol. Recommended for use as a diathermic fluid whenever accidental food contact is possible. Not suitable for use as a direct food component or additive. It is compatible with most other diathermic fluids based on mono ethylene glycol. Exclusive use of this product is recommended for optimum protection against corrosion. It must be mixed only with low hardness distilled water.

It protects metals and alloys used in systems against all forms of corrosion. The combination of low toxicity and FDA approved ingredients with a high level of corrosion protection makes this product unique on the market. Competing products often provide insufficient protection for aluminium and copper. Given the frequent use of copper in the food industry, the excellent protection that TEXA FLUID FOOD provides for it makes it a particularly suitable product.









General Information  
[info.texa@nvent.com](mailto:info.texa@nvent.com)



Technical Support  
[texa.service@nvent.com](mailto:texa.service@nvent.com)

*All efforts have been made to provide accurate data and descriptions.  
However, due to our continuous development and improvement of our products,  
all information in this catalogue is subject to change without notice.*



